

Nutri-Grade Mark for Nutri-Grade Beverages

Usage guide for graphic applications

REVISED JUNE 2023 VERSION 2.1

Revisions of “Usage guide for graphic applications”

Version 2.1

Date: June 2023

Remarks:

Version 2.1 replaces Version 2.0 as the updated guide. The Additional Measures indicated in yellow highlights have been published in the gazette on 30 June 2023, for implementation from 30 December 2023.

Version 2.0

Date: February 2023

Remarks:

MOH announced in 2020 that these measures will be extended to freshly prepared beverages (hereinafter referred to as “Additional Measures” in this document).

Version 2.0 served as an early release preliminary guidance to assist industry stakeholders to comply with the Current Measures and the Additional Measures, ahead of the gazettal of the Additional Measures.

Version 1.0

Date: December 2021

Remarks:

From 30 December 2022, Nutri-Grade beverages sold in Singapore in prepacked form that is not freshly prepared (“pre-packaged beverages”), and from dispensers (ABDs) are subject to labelling requirements and advertising prohibitions in the Food Regulations (hereinafter referred to as “Current Measures” in this document).

Version 1.0 served as a general guide to the labelling and advertising requirements for Nutri-Grade beverages, to assist industry stakeholders to comply with the requirements of the Food Regulations.

Should you have any queries, it is recommended that you refer to the Food Regulations and/or seek independent legal advice.

CONTENT

Nutri-Grade mark for Nutri-Grade Beverages

Introduction

Components and Specifications of the Mark

Grade and Sugar Level

Font Type and Colour Palette

Proportion and Grid

Mark Variants and Nutrient Thresholds

Full Nutri-Grade mark – Horizontal variants

Full Nutri-Grade mark – Vertical variants

Simplified Nutri-Grade mark

Sugar Declaration for Toppings mark

Mark variants and grading criteria

Usage Guidelines

Minimum Clear Space

Placement on Packaging

Individual Products

Multipacks

Size of Mark

Usage of mark in conjunction with the Healthier Choice Symbol (HCS)

Usage of mark in conjunction with the Healthier Dining Programme (HDP) Identifier

Size of mark - Materials that inform sale of Nutri-Grade beverage

Ideal application

Unapproved application

Product Packaging Application Examples

Application Examples – Individual Product Packages

Horizontal Variant – Cartons and Packet Drinks

Horizontal Variant – Cans and PET Bottles

Vertical Variant – Cans and Bottles

Application Examples – Multipacks

Multipack with Identical Products within Pack

Multipack with Different Products within Pack

Usage Guidelines for Non-Product Packaging Applications

Application – Automated Beverage Dispensers

Application – Vending Machines without Product Displays

Application – E-commerce Platforms

Application – Digital Advertisements

Application – Materials that inform sale of Nutri-Grade beverage

Section

1

1.1

2

2.1

2.2

2.3

3

3.1

3.2

3.3

3.4

3.5

4

4.1

4.2

4.2.1

4.2.2

4.3

4.4

4.5

4.6

4.7

4.8

5

5.1

5.1.1

5.1.2

5.1.3

5.2

5.2.1

5.2.2

6

6.1

6.2

6.3

6.4

6.5

Introduction

Fig. 1.1: Full Nutri-Grade mark – Horizontal Variant

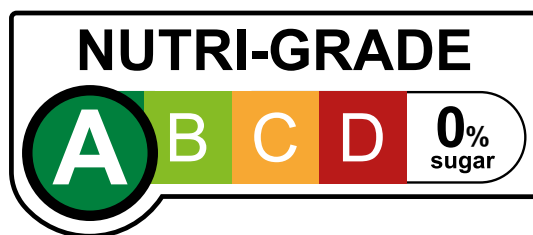

Fig. 2.1: Simplified Nutri-Grade mark

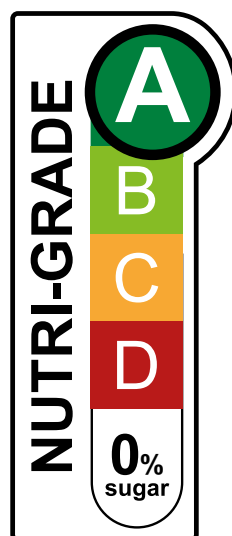

Fig. 1.2: Full Nutri-Grade mark – Vertical Variant

Fig. 2.2: Colour-coded scale



The Ministry of Health Singapore introduced mandatory nutrition labelling and advertising prohibitions for Nutri-Grade beverages in Singapore.

The measures aim to provide consumers with information about the sugar and saturated fat content in Nutri-Grade beverages, and to encourage the industry to develop lower-sugar, lower-fat alternatives so that consumers can make more informed choices across beverages and have healthier options to choose from.

There are four colour-coded grades for the Nutri-Grade mark. Grade A, corresponding to the lowest sugar and saturated fat thresholds, is in dark green. Grade D, corresponding to the highest sugar and saturated fat thresholds, is in red. Labelling of the Nutri-Grade mark is mandatory for Nutri-Grade beverages graded “C” and “D”, but voluntary for Nutri-Grade beverages graded “A” and “B”. Point-of-sale advertisements of pre-packaged Nutri-Grade beverages graded “D” in variety shops* have to display the Nutri-Grade mark.

The industry will have the flexibility to use either the Full or Simplified Nutri-Grade mark at platforms that list more than one beverage option (e.g. menus, e-commerce platforms, beverage dispensers). This also extends to pre-packaged multipacks that list the Nutri-Grade marks on the outer packaging. If the Simplified Nutri-Grade mark is used, the colour-coded scale (see Fig. 2.2) must also be visible. Where the platform only lists one beverage option (i.e. individual units), the Full Nutri-Grade mark is required.

This document has been produced to provide guidelines on how the Nutri-Grade mark should be applied on product packaging and other settings.

More details on the labelling and advertising requirements can be found in the Food Regulations and the Industry Guidance Document.

*A variety shop includes a convenience store, grocery shop, supermarket or other establishment however named that sells mainly a variety of food, small household items, toiletries and other small consumer goods.

Introduction

Fig. 3.1: Sugar Declaration for Toppings mark

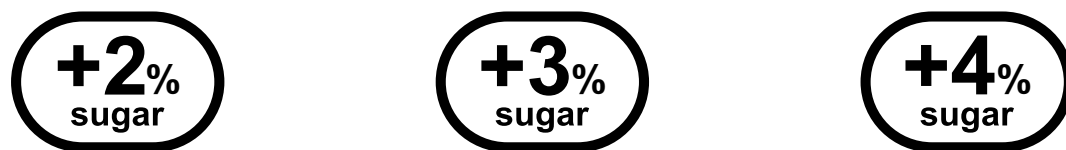

The sugar content of toppings must also be labelled with the Sugar Declaration for Toppings mark. This new measure aims to provide consumers with information about the sugar content in toppings, and to encourage the industry to develop lower-sugar alternatives so that consumers can make more informed choices across toppings and have healthier options to choose from.

Accordingly, the percentage of sugar content must be labelled for toppings that can be added onto the beverage and/or used to customise beverages on a menu, poster, sign or other material used to inform a prospective consumer that a topping is for sale. The industry is required to adhere to the format of the white bubbles labelled with the percentage of sugar content, i.e. '+x% sugar'. To reduce visual clutter, toppings with the same percentage of sugar content can also be grouped and labelled together, but it is not mandatory to do so.

This document has been produced to provide guidelines on how the Sugar Declaration for Toppings mark should be applied across menus, posters, signs or other materials.

Grade and Sugar Level

Grade

There are four colour-coded grades, from Grade A (dark green) to Grade D (red), based on the sugar and saturated fat content of the beverage. The grade of a particular beverage is determined based on the mark's underlying grading system, summarised in Section 3.5.

Sugar Level

In addition to the grade, Nutri-Grade mark includes the sugar level of the beverage, in the form of a percentage, rounded to the nearest whole number.

Components of the mark are fixed and cannot be changed or altered in any way. Only the value for the sugar content may be changed to reflect the accurate sugar content of the beverage.

More information on the grading system and how to derive the sugar content can be found within the Food Regulations and the Industry Guidance Document.

Statement

For a freshly prepared beverage which ingredient(s) may be customised by a prospective consumer (including those dispensed from a consumer-facing customisable automated beverage dispenser), a statement regarding the basis of the grading [e.g. Nutri-Grade mark is based on preparation at 120% sugar (before addition of ice)] has to be included at least once on every menu, poster, sign or other material that inform its sale. See section 6.5 for more examples of the statements.

Full Nutri-Grade mark – Horizontal Variant

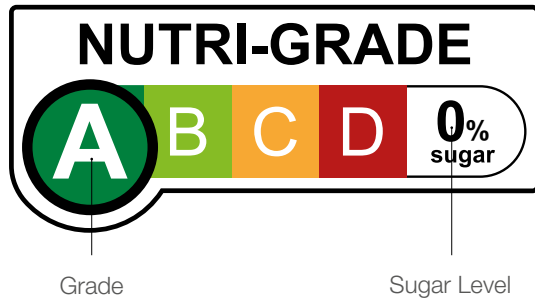

Full Nutri-Grade mark – Vertical Variant

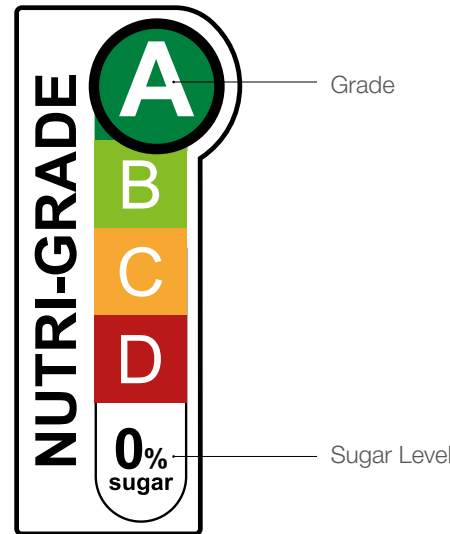

Simplified Nutri-Grade mark

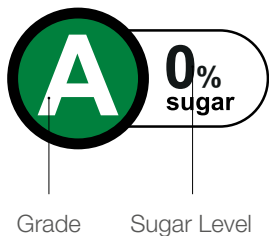

Colour-coded scale



Nutri-Grade mark is based on preparation at 120% sugar (before addition of ice)

Statement

**Whenever the Simplified Nutri-Grade mark is used, the colour-coded scale must also be visible.*

Font Type and Colour Palette

Arial Bold

ABCDEF GHIJK LMNOP QRSTUVW XYZ
 abcdefghijklmnopqrstuvwxyz
 1234567890%

Arial Bold Italic

ABCDEF GHIJK LMNOP QRSTUVW XYZ
 abcdefghijklmnopqrstuvwxyz
 1234567890%

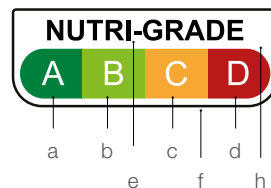
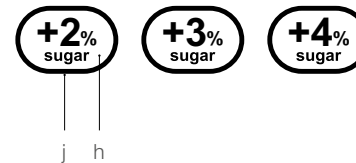
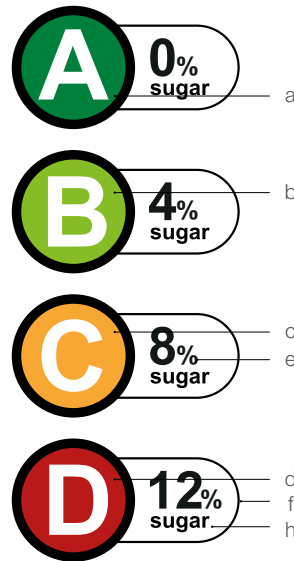
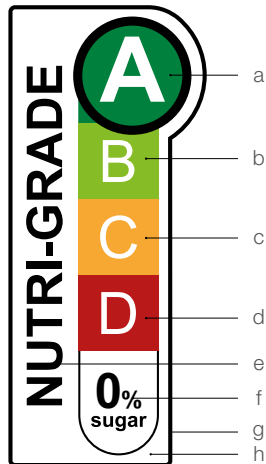
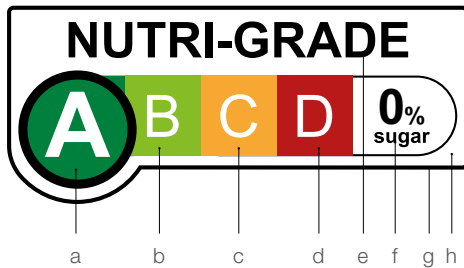

Nutri-Grade mark is based on preparation at 120% sugar (before addition of ice)

Font Type

Arial Bold is the only font that should be used to denote the sugar level. Other fonts and other weights of Arial are not permitted to be used.

Arial Bold Italic is the only font that should be used in the case of a Statement.

Colour Palette

The Nutri-Grade mark shall be printed in full colour CMYK or Pantone. Please refer to the Pantone codes for precise colour accuracy.

The Nutri-Grade mark cannot be printed or expressed in a monochrome palette.

The statement shall be printed in:

- Black C if the background of the material it is printed on is light coloured.
- White if the background is dark coloured.

	a	b	c	d	e, f, g, i, j	h
Pantone®	2423C	375C	1375C	2035C	Black C	
CMYK	100C 25M 100Y	55C 100Y	40M 85Y	20C 100M 100Y 8K	100K	White
RGB	R0 G128 B61	R134 G188 B37	R247 G168 B51	R183 G25 B24	R29 G29 B27	

Proportion and Grid

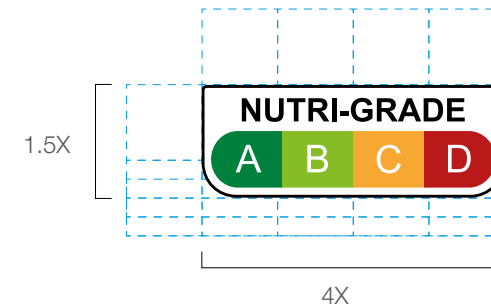
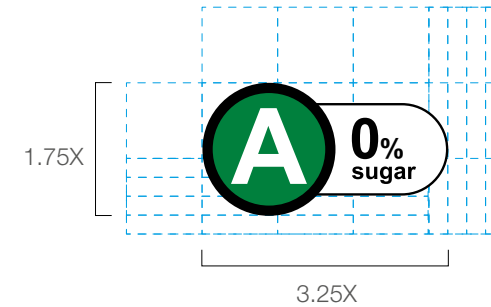
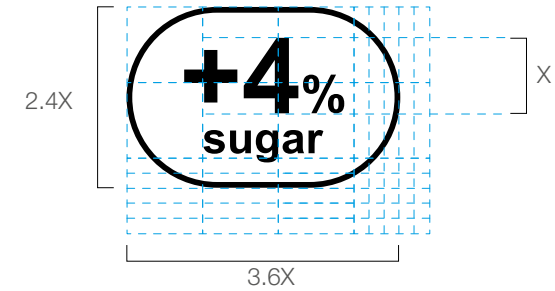
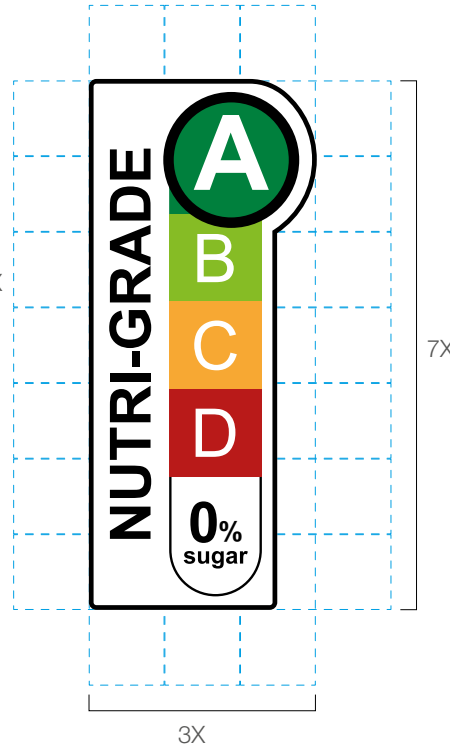
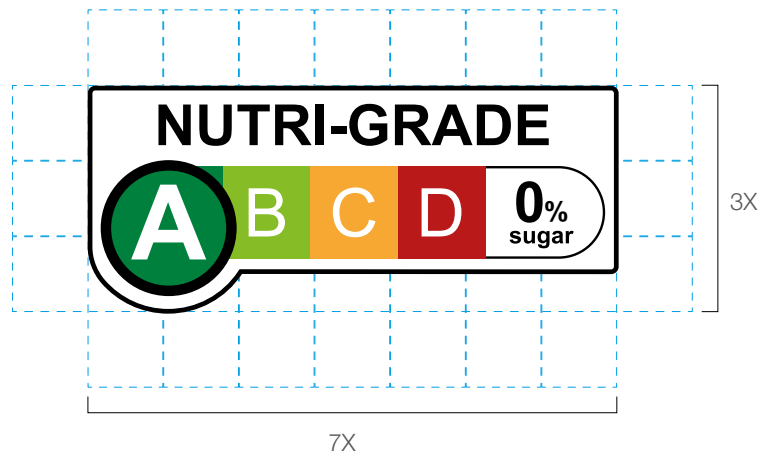
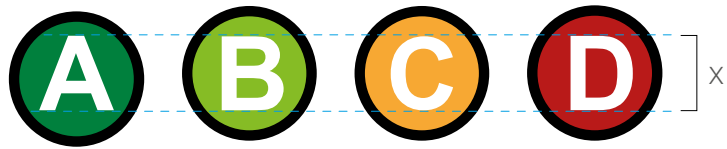

Proportion

The proportion relationships of the elements are fixed and shown in this guide. In all situations, the digital artwork shall be used as provided by the Singapore Government and must not be modified in any way, except to adjust proportionally to the required size and to insert the value for the sugar level.

Grid

The grid is determined by one cap height of the large letter versions of 'A', 'B', 'C' or 'D'. During application, please check the construction grid to ensure each section of the Nutri-Grade mark is within grid specifications.

Full Nutri-Grade mark – Horizontal Variants

Full Nutri-Grade mark Horizontal Variant 1.1

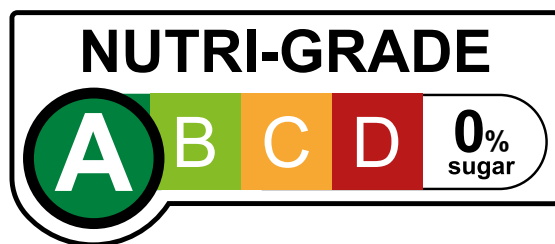

Full Nutri-Grade mark Horizontal Variant 1.2

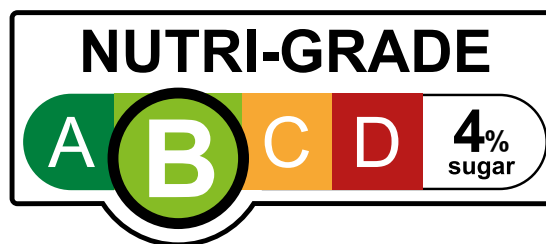

Full Nutri-Grade mark Horizontal Variant 1.3

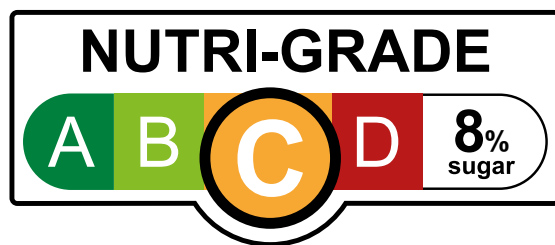

Full Nutri-Grade mark Horizontal Variant 1.4

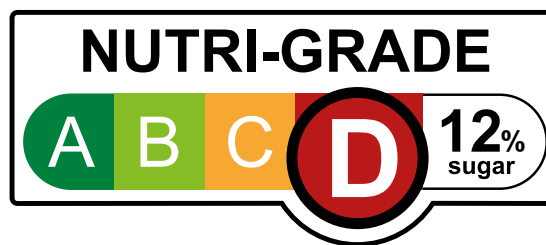

The Full Nutri-Grade mark is presented as both horizontal and vertical variants. Horizontal variants should be used as the default, except in situations where the vertical variant may be more appropriate (refer to Section 3.2).

Full Nutri-Grade mark – Vertical Variants

Full Nutri-Grade mark
Vertical Variant 2.1

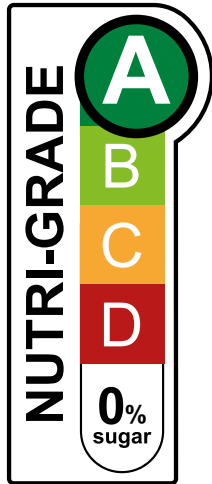

Full Nutri-Grade mark
Vertical Variant 2.2

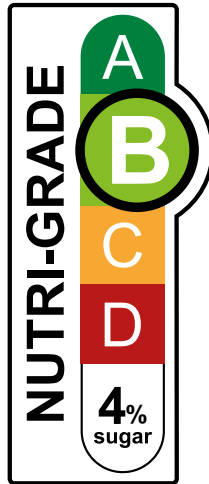

Full Nutri-Grade mark
Vertical Variant 2.3

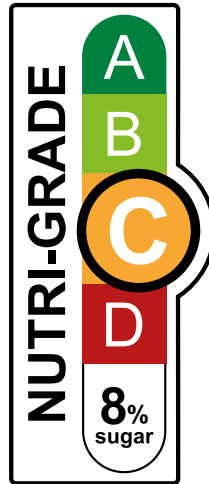

Full Nutri-Grade mark
Vertical Variant 2.4



Instances where vertical variants may be used:

The vertical variants may only be used when it is not possible to apply the horizontal variant in accordance to this usage guide. The use of the vertical variants includes but is not limited to the following scenarios:

1. There is insufficient horizontal space on the packaging to display the horizontal variant according to its minimum size and clear space required, as seen in Fig. 1 and 2 (refer to Section 4.1 and 4.3 for clear space and minimum size guidelines).
2. The background of the packaging is too busy such that the vertical variant would be more legible compared to the horizontal variant, as seen in Fig. 3 (refer to Section 5.1.3 for application example).

In the event that a company chooses to use the vertical variant, HPB may request for more information to justify the selection.

Example of instances where the vertical variant may be used

Fig. 1:

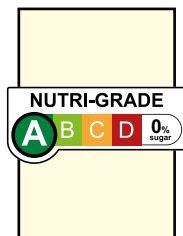

Fig. 2:

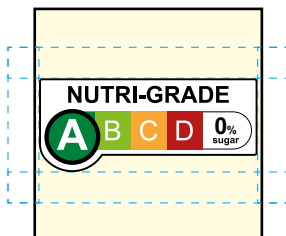
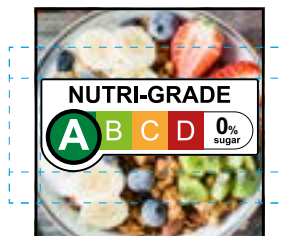

Fig. 3:



Simplified Nutri-Grade mark

Simplified Nutri-Grade mark Variant 1.1



Simplified Nutri-Grade mark Variant 1.2



Simplified Nutri-Grade mark Variant 1.3

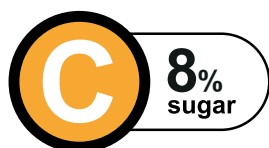

Simplified Nutri-Grade mark Variant 1.4



Colour-coded scale



Nutri-Grade mark is based on preparation at 120% sugar (before addition of ice)

**Whenever the Simplified Nutri-Grade mark is used, the colour-coded scale must also be visible.*

Instances where the Simplified Nutri-Grade mark may be used:

The Simplified Nutri-Grade mark is presented as a horizontal variant only. The use of the Simplified Nutri-Grade mark includes but is not limited to the following scenarios:

1. At platforms that list more than one beverage option (e.g. menus, e-commerce platforms, beverage dispensers)
2. On opaque outer packaging of multipacks that contain more than one product type (e.g. variety packs)

Do note that regardless of whether the Full or Simplified Nutri-Grade mark is used, the outer packaging of multipacks must include a statement that each unit in the package must not be sold separately or a statement to the same effect (e.g. "Not to be sold separately"). If the Simplified Nutri-Grade mark is used, the colour-coded scale must be visible.

For a freshly prepared beverage which ingredient(s) may be customised by a prospective consumer (including those dispensed from a consumer-facing customisable automated beverage dispenser), a statement regarding the basis of the grading [e.g. Nutri-Grade mark is based on preparation at 120% sugar (before addition of ice)] has to be included at least once on every menu, poster, sign or other material that inform its sale. See section 6.5 for more examples of the statements.

Sugar Declaration for Toppings mark

Sugar Declaration for Toppings mark - Variant 1.1

Customise Any Drink

Flavour:

Flavour A, Flavour B, Flavour C

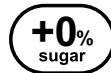

Choice of Dairy:

Milk A, Milk B

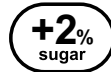

Alternative Milk A, Alternative Milk B

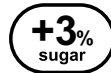

Add-in:

Add-in A, Add-in B

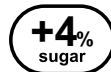

Sugar Declaration for Toppings mark - Variant 1.2

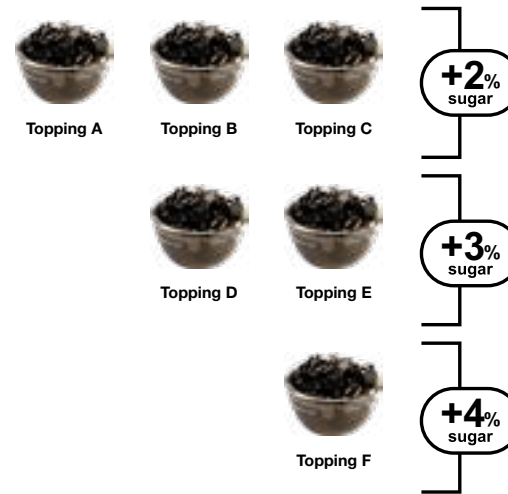

The Sugar Declaration for Toppings mark can be used to group and label toppings of the same percentage of sugar content together (Variant 1.1 to 1.3), but it is not mandatory to do so. The industry is only required to adhere to the format of the white bubbles labelled with the percentage of sugar content, i.e. '+x% sugar'.

An alternative declaration in text (Variant 1.4) may be used only when the display of Sugar Declaration for Toppings mark is not possible, such as when there are limitations on digital and app platforms which only allow for the display of text and not images. The key components of the Sugar Declaration for Toppings mark must be reflected (i.e., the incremental amount of sugar from the toppings, reflected in terms of % per 100g of toppings).



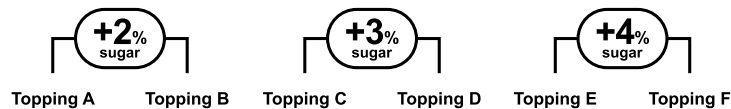









Sugar Declaration for Toppings mark - Variant 1.3



Alternative Plain Text Display of the Sugar Declaration for Toppings mark – Variant 1.4

- Topping A (+2% sugar) +1.00
- Topping B (+2% sugar) +1.00
- Topping C (+3% sugar) +1.00
- Topping D (+3% sugar) +1.00
- Topping E (+4% sugar) +1.00
- Topping F (+4% sugar) +1.00

Mark Variants and Grading Criteria

Grade	Full Nutri-Grade mark – Horizontal Variants	Full Nutri-Grade mark – Vertical Variants	Simplified Nutri-Grade mark*	Nutrient Threshold
A				<p>≤ 1g/100ml sugar¹</p> <p>≤ 0.7g/100ml saturated fat</p> <p>No non-sugar substitutes²</p>
B				<p>> 1-5g/100ml sugar¹</p> <p>> 0.7-1.2g/100ml saturated fat</p>
C				<p>> 5-10g/100ml sugar¹</p> <p>> 1.2-2.8g/100ml saturated fat</p>
D				<p>> 10g/100ml sugar¹</p> <p>> 2.8g/100ml saturated fat</p>

The grade is determined by the sugar and saturated fat content of the beverage as indicated in the table. Grade A corresponds to the lowest sugar and saturated fat thresholds, and Grade D corresponds to the highest sugar and saturated fat thresholds. The grade of a Nutri-Grade beverage is the lower of the following:

- a. The sugar content grade, and
- b. The saturated fat content grade.

In addition, beverages graded “A” must not contain any non-sugar substitutes².

More information on the grading system and nutrient thresholds can be found within the Food Regulations and the Industry Guidance Document.

¹ This refers to the grams of total sugar per 100 ml, minus the grams of lactose and galactose per 100 ml, as declared on the Nutrition Information Panel (NIP). If the amount(s) of lactose and/or galactose are not declared on the NIP, they are taken to be zero.

² This refers to any aspartame, sugar alcohol, carbohydrate alcohol, polyhydric alcohol, or any other substance added in place of sugar to provide a sweet taste.



*Whenever the Simplified Nutri-Grade mark is used, the colour-coded scale must also be visible.

Full Nutri-Grade mark – Minimum Clear Space

Horizontal Variant

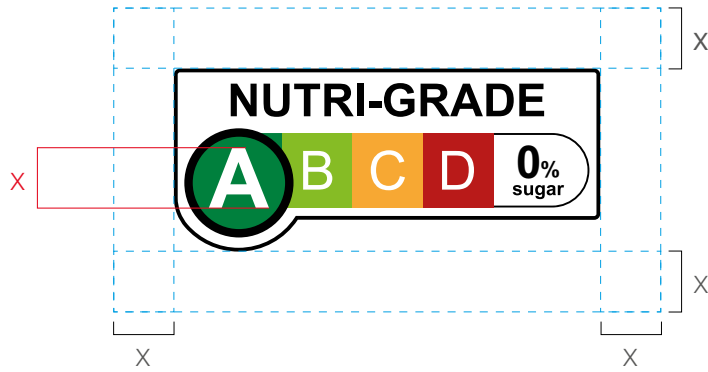

Example of Clear Space

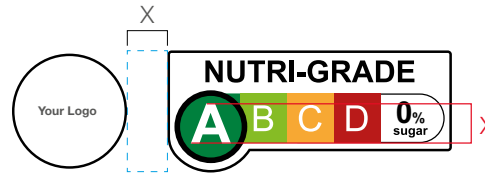

Vertical Variant

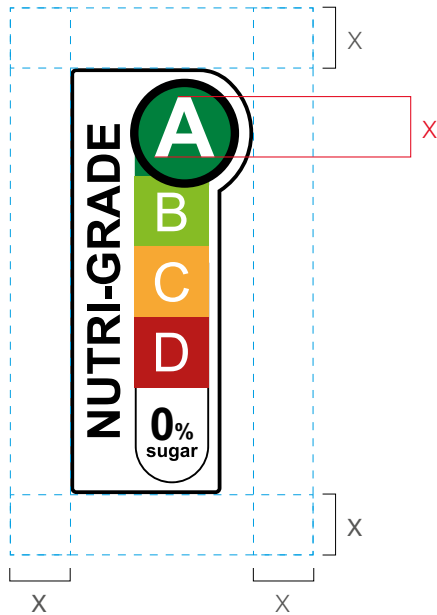

Example of Clear Space

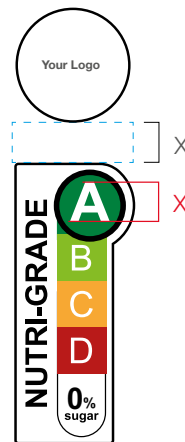

Minimum Clear Space

For maximum legibility and visibility, always ensure the minimum clear space around the Nutri-Grade mark. The minimum clear space is one cap height of the large letter versions of 'A', 'B', 'C' or 'D'.

Simplified Nutri-Grade mark – Minimum Clear Space

Example of Clear Space

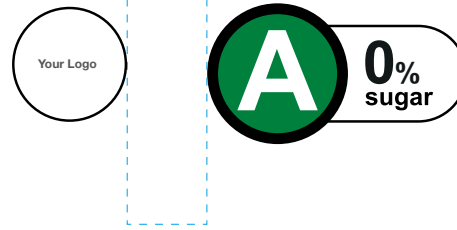
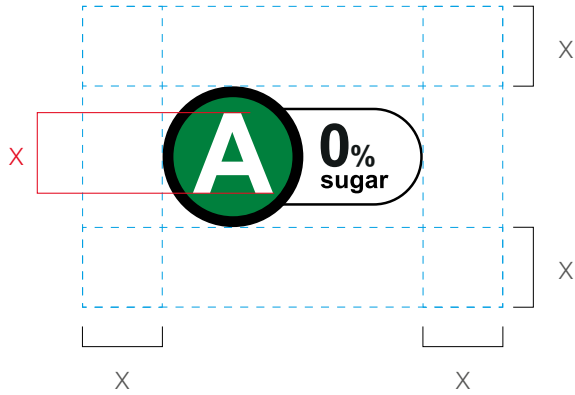

Minimum Clear Space

For maximum legibility and visibility, always ensure the minimum clear space around the Nutri-Grade mark. The minimum clear space is one cap height of the large letter versions of 'A', 'B', 'C' or 'D'.

Whenever the Simplified Nutri-Grade mark is used, the colour-coded scale must also be visible.

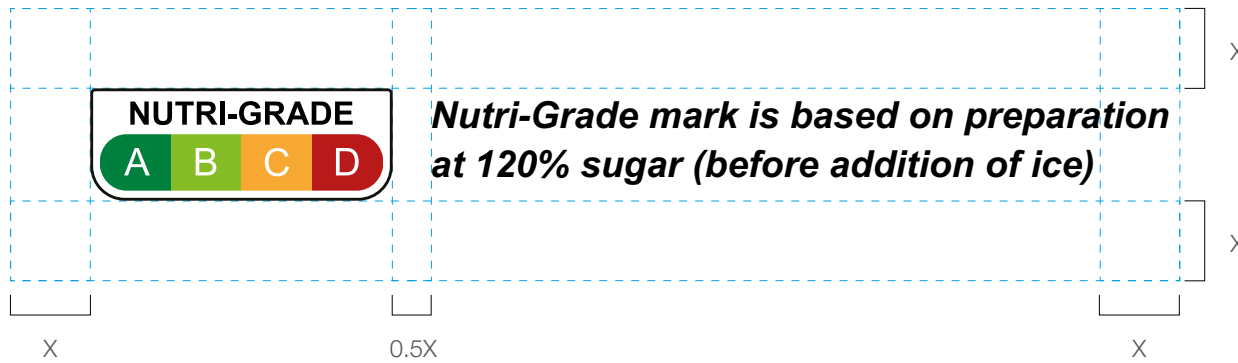

Example of Clear Space

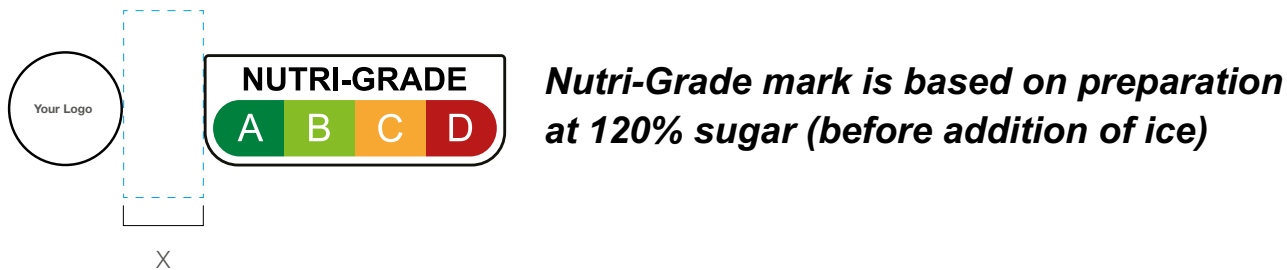

Sugar Declaration for Toppings mark – Minimum Clear Space

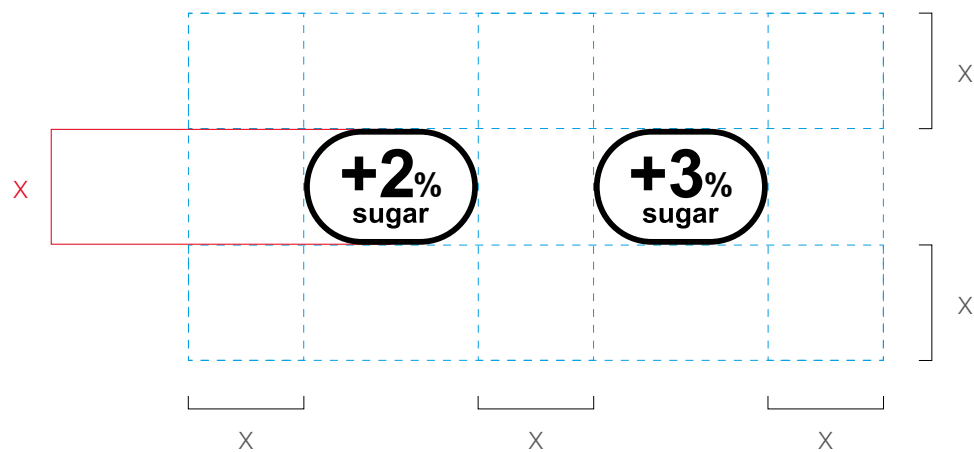

Minimum Clear Space

For maximum legibility and visibility, always ensure the minimum clear space around the Sugar Declaration for Toppings mark. The minimum clear space is the height of the white bubble, as shown by 'X'.

Placement on Packaging – Individual Products

Fig. 1:
FOP area of packages with full printed area

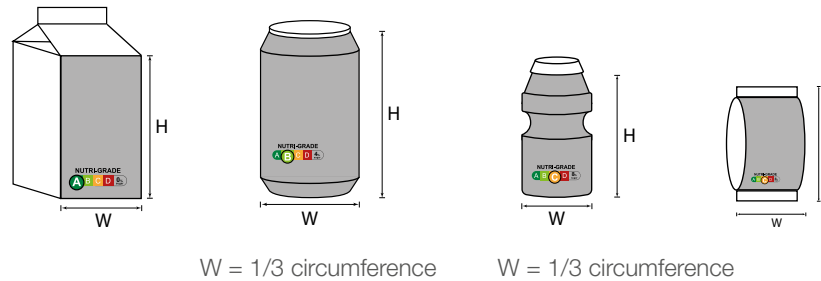

Fig. 2:
FOP area of packages with partial printed areas, product sleeves or package labels

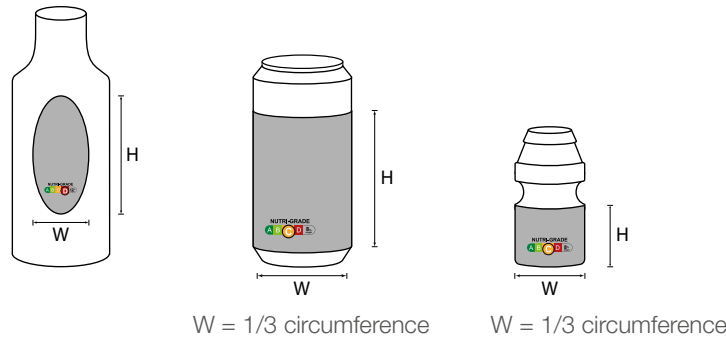
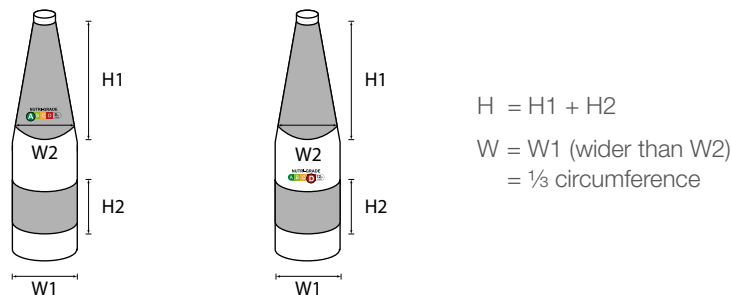

Fig. 3:
FOP area of packages with multiple printed areas, product sleeves or package labels



General Packaging Guidelines

- The Nutri-Grade mark should be on the front-of-pack (FOP) surface of the product package.
- The FOP is the front face of the product package where the Nutri-Grade beverage's name and brand (if there is a brand) appear; and that is in a prospective consumer's principal field of vision.

For packages that have multiple surfaces that fulfil the definition of FOP (e.g. rectangular carton where both front and back are identical and contain the key product information), the Nutri-Grade mark is required on at least one surface and the surface carrying the Nutri-Grade mark should face a prospective consumer by default at point of sale.

- By default, the Nutri-Grade mark should be within the printed area, product sleeve or package label. If this is not possible, it can be elsewhere on the front face of the package.
- In all cases, the FOP area is determined by the height H and width W of the printed area, product sleeve or package label of the package.
- If the package has more than one printed area, product sleeve or package label, the dimensions of the total FOP area are (see Fig. 3):
 - a) Total H = the sum of the height of each printed area, product sleeve or package label.
 - b) Total W = the width of the widest printed area, product sleeve or package label.
- If the platform only lists one beverage option (i.e. individual units), the Full Nutri-Grade mark is required.
- If individual units in a multipack are directly provided to consumers at specified settings (e.g. at workplace pantries or at hotels), these individual units will need to be labelled with the Full Nutri-Grade mark.

Placement on Packaging – Multipacks

FOP area of multipacks

Fig. 1:
FOP area of multipacks with transparent outer packaging that fulfills scenario (a)

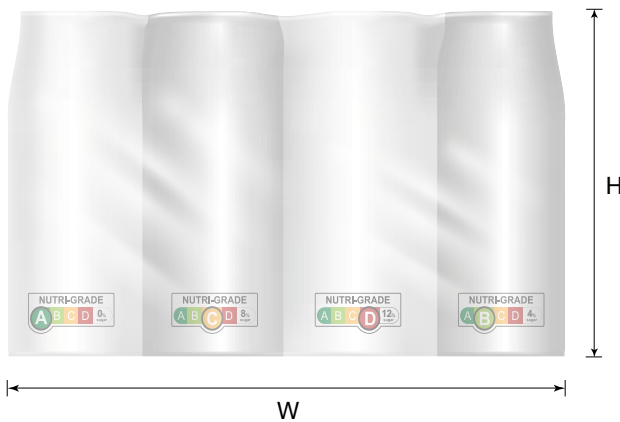

Fig. 2:
FOP area of multipacks with opaque outer packaging that fulfills scenario (b)



Fig. 3:
FOP area of multipacks with opaque outer packaging that fulfills scenario (b)



General Packaging Guidelines

Multipack is a pack of several individual pre-packaged units of beverage products, which are grouped and sold together within an outer packaging such as a plastic sleeve wrapper or a cardboard pack or box.

- a. The Full Nutri-Grade mark must be used when the outer packaging of the multipack is wholly transparent (e.g. clear plastic sleeve) and the Full Nutri-Grade mark on each unit within the multipack is clearly visible by a prospective consumer through the outer packaging, as seen in Fig. 1. In this case, the Full Nutri-Grade mark will have to be marked on or securely attached to the FOP surface of each unit of the pre-packaged Nutri-Grade beverage in the multipack.
- b. Either the Full or Simplified Nutri-Grade mark may be used in respect to each Nutri-Grade beverage, when the multipack contains more than one product type. Regardless of whether the Full or Simplified Nutri-Grade mark is used, the outer packaging of the multipack must include a statement that each unit in the package must not be sold separately or a statement to the like effect (e.g. “Not to be sold separately”), as seen in Fig. 2 and Fig. 3.

- If the Simplified Nutri-Grade mark is used, the colour-coded scale must be visible.
- The Simplified Nutri-Grade mark can only be marked on or securely attached to the FOP surface of the outer packaging of the multipack and not the units of the pre-packaged Nutri-Grade beverage.

Industry may also mark or securely attach the Full Nutri-Grade mark to both the front-of-pack surface of each individual unit of beverage and the outer packaging of the multipack.

More information on when the above scenarios would apply can be found within the Food Regulations and the Industry Guidance Document.

Size of Full Nutri-Grade mark

Long side of Horizontal Variant

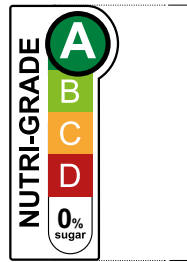
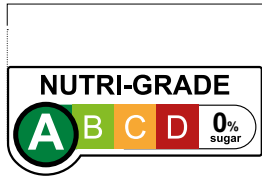

Long side of Vertical Variant

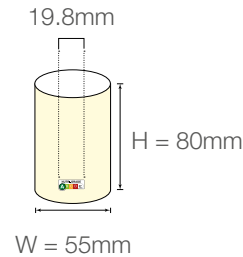
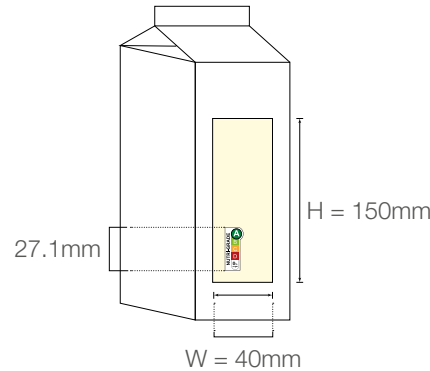
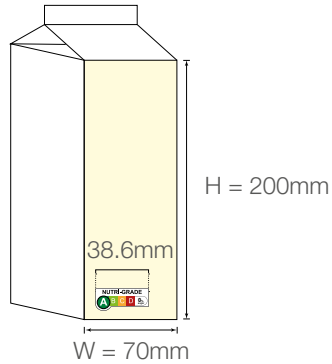

**Example 1:
Carton Box with large FOP area**

Length of Long Side of Horizontal Variant
 = $(H+W) / 7$
 = $(200\text{mm}+70\text{mm}) / 7$
 = 38.6mm

Minimum length of the horizontal variant for this packaging is 38.6mm

**Example 2:
Carton Box with small FOP area**

Length of Long Side of Vertical Variant
 = $(H+W) / 7$
 = $(150\text{mm}+40\text{mm}) / 7$
 = 27.1mm

Minimum length of the vertical variant for this packaging is 27.1mm

**Example 3:
Can with small FOP Area**

Length of Long Side of Horizontal Variant
 = $(H+W) / 7$
 = $(80\text{mm}+55\text{mm}) / 7$
 = 19.3mm (shorter than minimum size)
 = 19.8mm (round up to minimum size)

Minimum length of the horizontal variant for this packaging is 19.8mm

Calculation of Mark Size

The size of the Full Nutri-Grade mark should be proportional to the FOP surface area and calculated as follows:

Length of long side of Nutri-Grade mark = $(H+W) / 7$

The Nutri-Grade mark can be bigger than the calculated size but should not be smaller than what the calculation yields.

Minimum Size

To maintain legibility, the horizontal variant should never be smaller than 19.8mm wide by 8.5mm high and the vertical variant should never be smaller than 8.5mm wide and 19.8mm high. The minimum size should only be used when layout space is extremely limited.

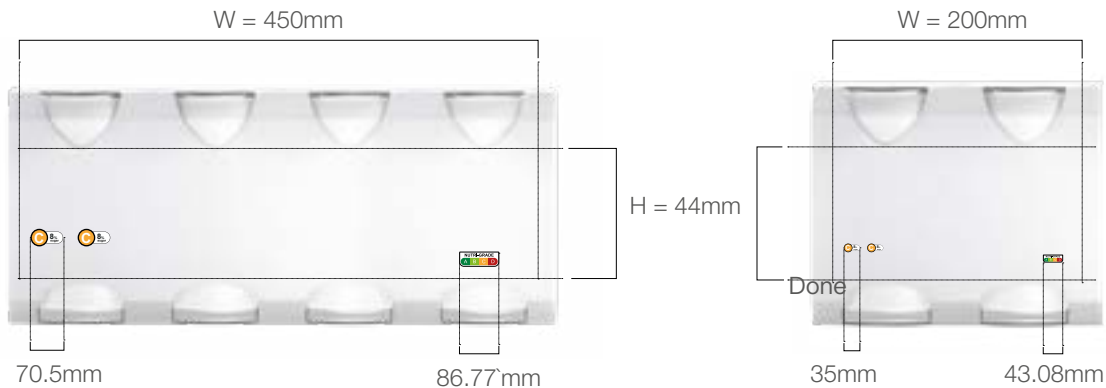

Size of Simplified Nutri-Grade mark

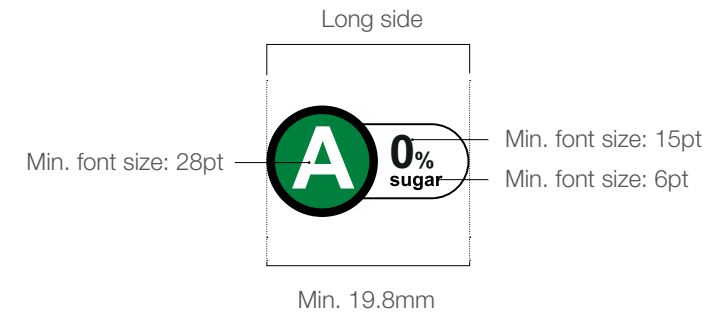

Example 1: Multipack with large FOP area

Calculation of the length of the Simplified Nutri-Grade mark

$$\begin{aligned} \text{Length of Long Side} &= (H+W) / 7 \\ &= (450\text{mm}+44\text{mm}) / 7 \\ &= 70.5\text{mm} \end{aligned}$$

Minimum length of the colour-coded scale for this packaging is 70.5mm

Calculation of the length of the colour coded scale

$$\begin{aligned} \text{Length of long side} &= (70.5\text{mm} / 3.25) \times 4 \\ &= 86.77\text{mm} \end{aligned}$$

Example 2: Multipack with small FOP area

Calculation of the length of the Simplified Nutri-Grade mark

$$\begin{aligned} \text{Length of Long Side} &= (H+W) / 7 \\ &= (200\text{mm}+44\text{mm}) / 7 \\ &= 35\text{mm} \end{aligned}$$

Minimum length of the colour-coded scale for this packaging is 35mm

Calculation of the length of the colour coded scale

$$\begin{aligned} \text{Length of long side} &= (35\text{mm} / 3.25) \times 4 \\ &= 43.08\text{mm} \end{aligned}$$

Calculation of Mark Size

The size of the Simplified Nutri-Grade mark should be proportional to the FOP surface area and calculated as follows:

$$\text{Length of long side of Simplified Nutri-Grade mark} = (H+W) / 7$$

The Simplified Nutri-Grade mark can be bigger than the calculated size but should not be smaller than what the calculation yields.

Minimum Size

To maintain legibility, the Simplified Nutri-Grade mark should never be smaller than 19.8mm wide by 8.5mm high. The minimum size should only be used when layout space is extremely limited.

Usage of Full Nutri-Grade mark in conjunction with the Healthier Choice Symbol (HCS)

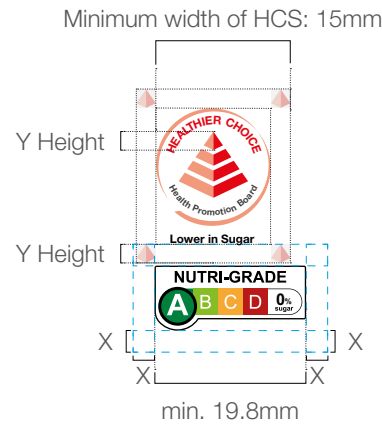
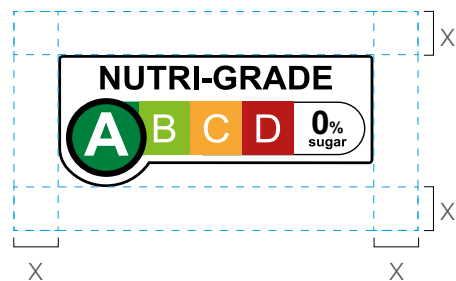
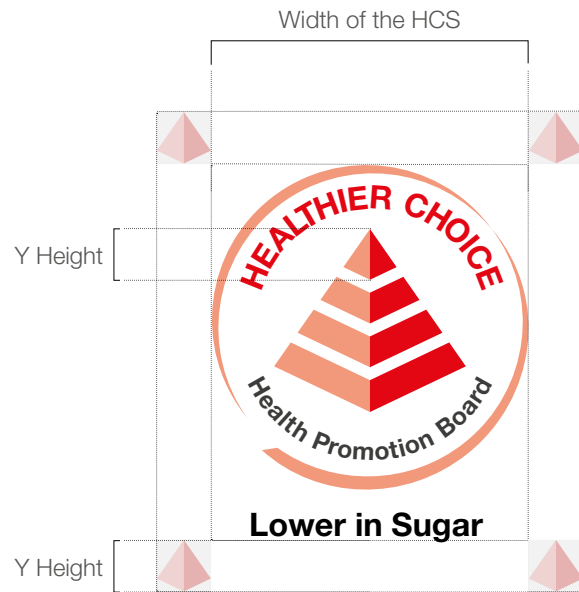

Minimum width of HCS is 15mm. If the width of HCS is less than 19.8mm, the Nutri-Grade mark will remain at its minimum size of 19.8mm.

Nutri-Grade mark will flush left in reference to the placement of the HCS.

Nutri-Grade mark usage on HCS-certified products need to adhere to the following:

1. The usage guidelines of both the Nutri-Grade mark and the HCS must be adhered to (refer to the Healthier Choice Symbol & Identifier Usage Guidelines for HCS usage guidelines).
2. When located beside each other, the minimum clear space will follow either that of the Nutri-Grade mark or the HCS, depending on whichever is bigger in size.
3. The size of the Nutri-Grade mark should be determined based on the formula in Section 4.3, but no smaller than 19.8mm on the long side.
4. Nutri-Grade mark should only be used in its full colour form.

Usage of Simplified Nutri-Grade mark in conjunction with the Healthier Choice Symbol (HCS)

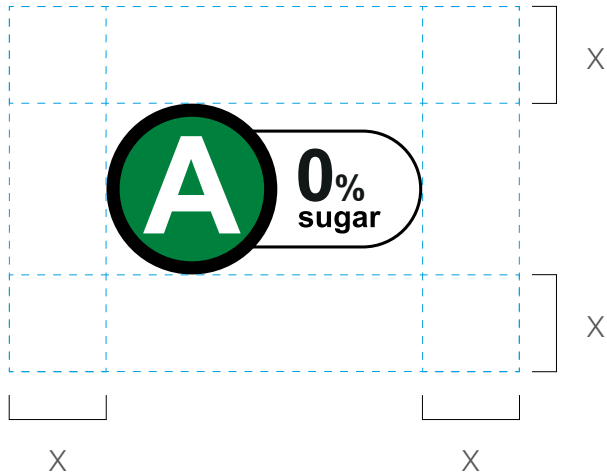
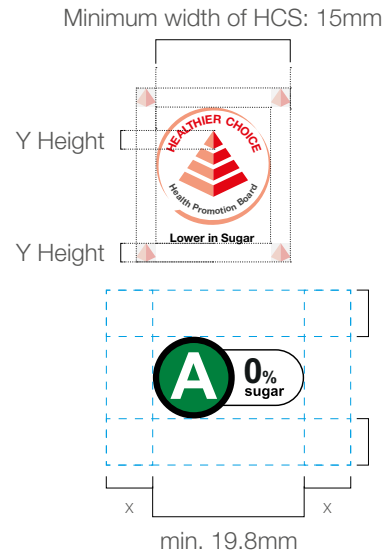
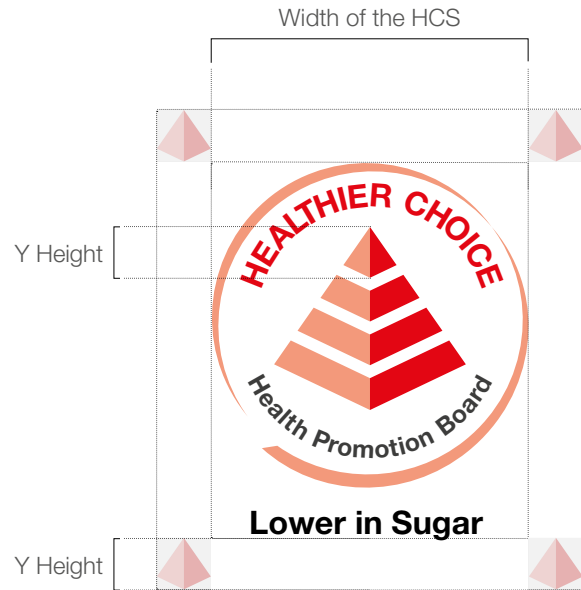

Simplified Nutri-Grade mark usage on HCS-certified products need to adhere to the following:

1. The usage guidelines of both the Simplified Nutri-Grade mark and the HCS must be adhered to (refer to the Healthier Choice Symbol & Identifier Usage Guidelines for HCS usage guidelines).
2. When located beside each other, the minimum clear space will follow either that of the Simplified Nutri-Grade mark or the HCS, depending on whichever is bigger in size.
3. The size of the Simplified Nutri-Grade mark should be determined based on the formula in Section 4.3, but no smaller than 19.8mm on the long side.
4. Simplified Nutri-Grade mark should only be used in its full colour form.

Minimum width of HCS is 15mm. If the width of HCS is less than 19.8mm, the Simplified Nutri-Grade mark will remain at its minimum size of 19.8mm.

Simplified Nutri-Grade mark will flush left in reference to the placement of the HCS.

Usage of mark in conjunction with the Healthier Dining Programme (HDP) Identifier

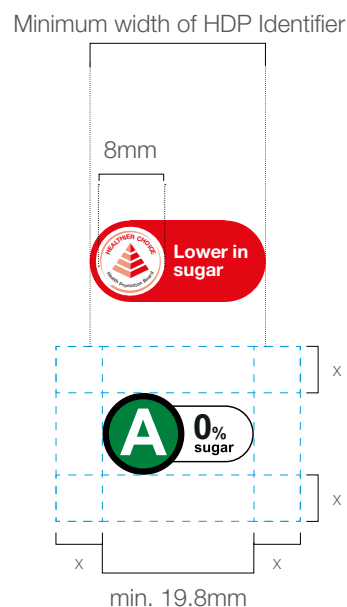
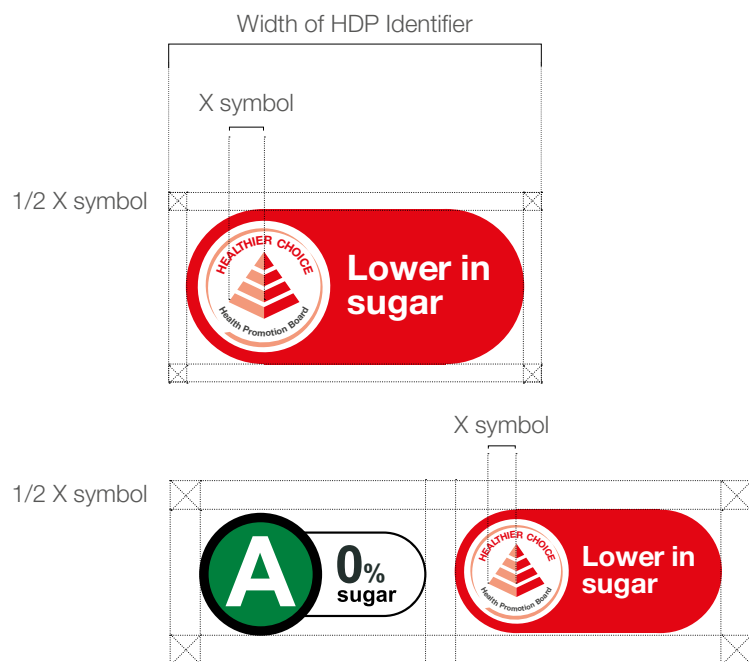

Nutri-Grade mark usage on HDP-certified beverages need to adhere to the following: (the Nutri-Grade mark here refers to both Full and Simplified variants)

1. The usage guidelines of both the Nutri-Grade mark and the HDP dish tag identifier must be adhered to (refer to the Healthier Dining Programme Identifier & Usage Guidelines for HDP usage guidelines)
2. When located beside each other, the minimum clear space will follow either that of the Nutri-Grade mark or the HDP dish tag identifier, depending on whichever is bigger in size.
3. The size of the Nutri-Grade mark should be determined based on the formula in section 4.3, but no smaller than 19.8mm on the long side.
4. The Nutri-Grade mark should only be used in its full colour form.

Minimum width of the main symbol within the HDP identifier should never be smaller than 8mm wide for collaterals like menus and 30mm wide for menu boards. If the width of the main symbol is less than 19.8mm, the Nutri-Grade mark will remain at its minimum size of 19.8mm. Nutri-Grade mark will flush left or top in reference to the placement of the HCS.

Note:

- If the reference variant used for HDP differs from that use for the Nutri-Grade mark, the HDP Identifier should not be applied to the same item that the Nutri-Grade mark is applied to.
- If the reference variant used for HDP is the same as that used for the Nutri-Grade mark, the HDP Identifier can be applied to the same item that the Nutri-Grade mark is applied to.

Size of Full Nutri-Grade mark – Materials that inform sale of Nutri-Grade beverage¹

Example of a Full Nutri-Grade mark on materials that inform sale of Nutri-Grade beverage to prospective consumers

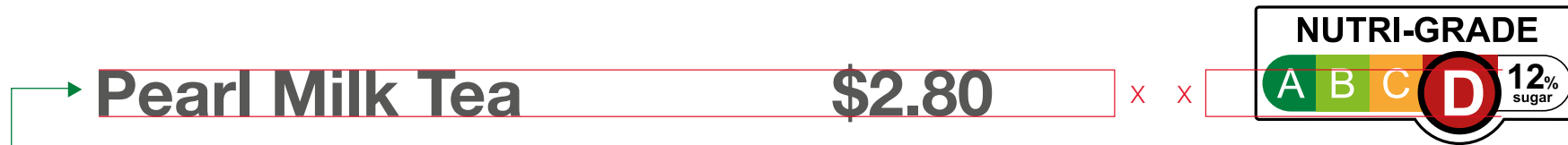

Milk Tea	
Earl Grey Milk Tea	\$2.80
Pearl Milk Tea	\$2.80
Milk Tea with Herbal Jelly	\$3.20
Brown Sugar Milk Tea	\$3.80
Taro Drink	\$4.00
Creative Mix	
Passion Fruit Green Tea	\$2.80
Lemon Juice with White Pearl & Aiyu	\$2.80
Mango Green Tea	\$3.20
Lemon with Aloe Vera	\$3.80
Hot Tea	
Lemon Lime Green Tea	\$2.80
Yuzu Oolong Tea	\$2.80

Choose Your Sugar Level

120%
100%
70%
50%
30%
0%

Choose Your Toppings

Topping A Topping B Topping C

Topping D Topping E

Topping F

Size Definition

- The Full Nutri-Grade mark should be adjusted proportionally to the appropriate size to ensure legibility.
- The height of the letter grade should be the same as that of the name/price of the item listed (whichever is smaller);
- Should there be different font sizes used within the name/price, the height of the letter grade should be the same as that of the largest letter/number within the name/price.

¹ Examples include menus, posters, signs, etc.

Size of Simplified Nutri-Grade mark – Materials that inform sale of Nutri-Grade beverage¹

Example of a Simplified Nutri-Grade mark on materials that inform sale of Nutri-Grade beverage to prospective consumers

Pearl Milk Tea

\$2.80

Milk Tea

Earl Grey Milk Tea	\$2.80
Pearl Milk Tea	\$2.80
Milk Tea with Herbal Jelly	\$3.20
Brown Sugar Milk Tea	\$3.80
Taro Drink	\$4.00

Creative Mix

Passion Fruit Green Tea	\$2.80
Lemon Juice with White Pearl & Aiyu	\$2.80
Mango Green Tea	\$3.20
Lemon with Aloe Vera	\$3.80

Hot Tea

Lemon Lime Green Tea	\$2.80
Yuzu Oolong Tea	\$2.80

Choose Your Sugar Level

120%

100%

70%

50%

30%

0%

Choose Your Toppings

Size Definition

The Simplified Nutri-Grade mark should be adjusted proportionally to the appropriate size to ensure legibility.

For the Simplified Nutri-Grade mark:

- The height of the letter grade should be the same as that of the name/price of the item listed (whichever is smaller);
- Should there be different font sizes used within the name/price, the height of the letter grade should be the same as that of the largest letter/number within the name/price;

1.5X

Nutri-Grade mark is based on preparation at 120% sugar (before addition of ice) 0.5X

For the colour-coded scale:

- The height of the scale should be 1.5 times that of the name/price of the beverage item (whichever is smaller); and
- Should there be different font sizes used within the name/price, the height of the scale should be 1.5 times that of the largest letter/number within the name/price;

For the statement stating the basis of the grading:

- The height of the letters should be 0.5 times that of the name/price of the beverage item (whichever is bigger); and
- Should there be different font sizes used within the name/price, the height of the letters should be the same as that of the largest letter/number within the name/price.

Nutri-Grade mark is based on iced version at 120% sugar.

Nutri-Grade mark is based on hot version using default preparation.

¹ Examples include menus, posters, signs, etc.

Size of Sugar Declaration for Toppings mark – Materials that inform sale of Nutri-Grade beverage¹

Example of Sugar Declaration for Toppings mark on materials that inform sale of Nutri-Grade beverage to prospective consumers

Pearl Milk Tea

\$2.80

× ×

+2%
sugar

Milk Tea		
Earl Grey Milk Tea	C 8%	\$2.80
Pearl Milk Tea	D 12%	\$2.80
Milk Tea with Herbal Jelly	C 8%	\$3.20
Brown Sugar Milk Tea	D 12%	\$3.80
Taro Drink	C 8%	\$4.00

Creative Mix		
Passion Fruit Green Tea	C 8%	\$2.80
Lemon Juice with White Pearl & Aiyu	D 12%	\$2.80
Mango Green Tea	C 8%	\$3.20
Lemon with Aloe Vera	D 12%	\$3.80

Hot Tea		
Lemon Lime Green Tea	C 8%	\$2.80
Yuzu Oolong Tea	D 12%	\$2.80

Choose Your Sugar Level

120%
100%
70%
50%
30%
0%

Choose Your Toppings

Topping A

Topping B

Topping C

+

+2%
sugar

+

Topping D

Topping E

+

+3%
sugar

+

Topping F

+

+4%
sugar

Size Definition

- The Sugar Declaration for Toppings mark should be adjusted proportionally to the appropriate size to ensure legibility.
- The height of the numerical values for the percentage of sugar content should be the same as that of the name/price of the beverage item (whichever is smaller).
- Should there be different font sizes used within the name/price, the height of the numerical value should be the same as that of the biggest letter/number within the name/price.

¹ Examples include menus, posters, signs, etc.

Ideal Applications

Application of Full Nutri-Grade mark

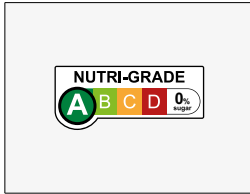
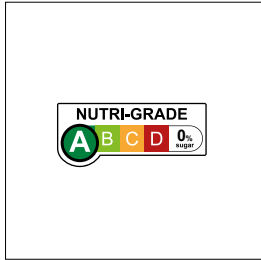

5% Black Tint BG



40% Black Tint BG

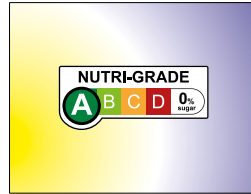

Light Graduated BG

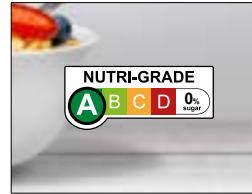

Less Busy Image Area

Application of Simplified Nutri-Grade mark

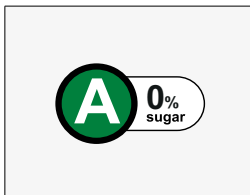
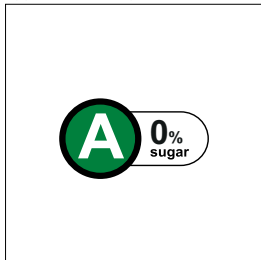

5% Black Tint BG

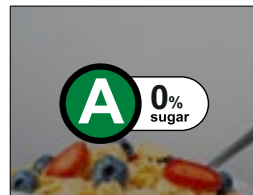

40% Black Tint BG

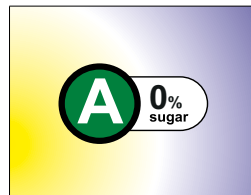

Light Graduated BG



Less Busy Image Area

Application of Colour-coded scale

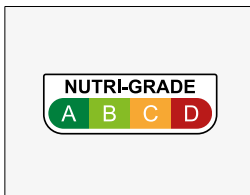
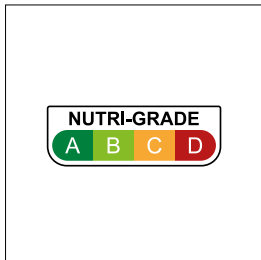

5% Black Tint BG

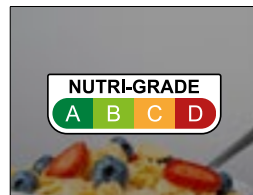

40% Black Tint BG

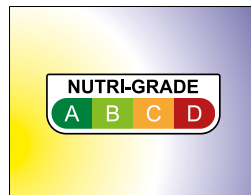

Light Graduated BG

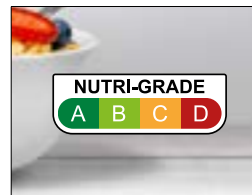

Less Busy Image Area

Application of Sugar Declaration for Toppings mark

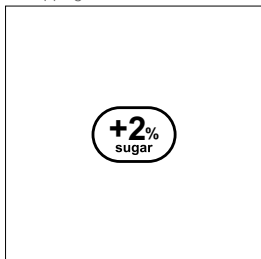

5% Black Tint BG

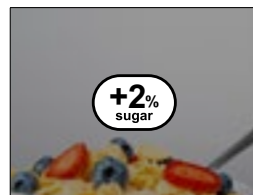

40% Black Tint BG

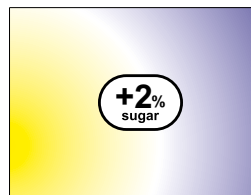

Light Graduated BG



Less Busy Image Area

Ideal application

The Full Nutri-Grade mark, Simplified Nutri-Grade mark, colour-coded scale, and the Sugar Declaration for Toppings mark should be applied in their full-colour forms in all situations. The marks should be applied on a plain or white background where possible. They may also be applied on a dark or photographic background as long as the background is not too busy or distracting and will not affect the legibility of the marks.

Unapproved Applications

Full Nutri-Grade mark

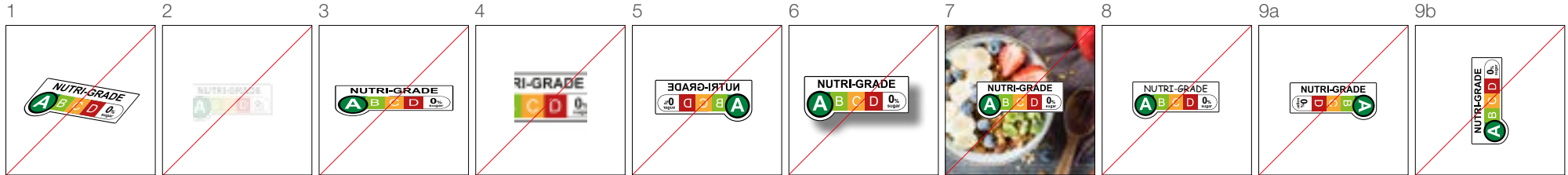

Simplified Nutri-Grade mark

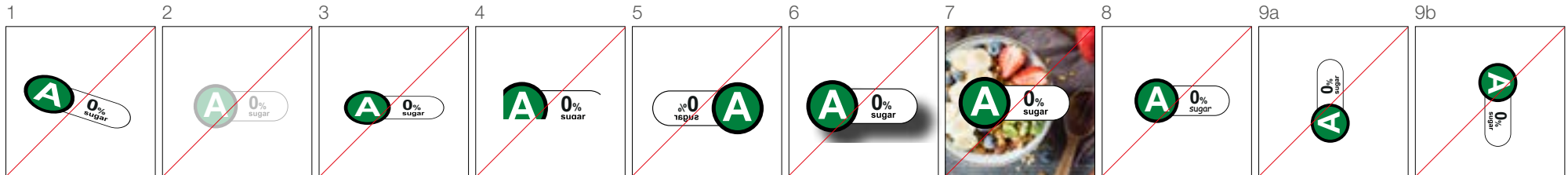

Sugar Declaration for Toppings mark

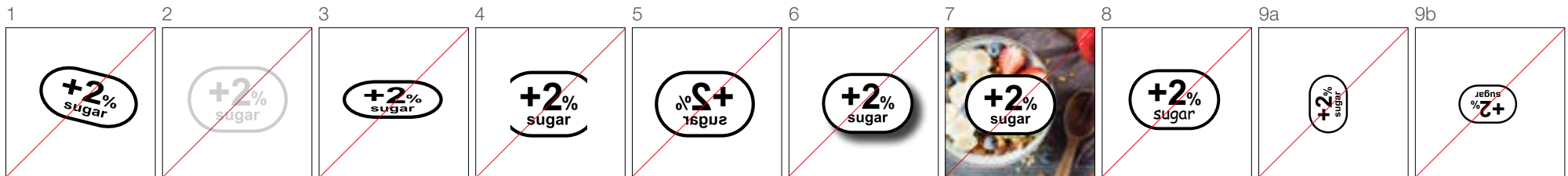

Full Nutri-Grade mark; Simplified Nutri-Grade mark; and Sugar Declaration for Toppings mark should be consistent, following the guidelines in this document. The following are examples of unapproved usage of the marks.

Please do not:

1. Change or alter the mark in any way, such as skewing or rotating the mark.
2. Combine the mark with any other graphic element or use as a watermark.
3. Disproportionately scale the mark.
4. Crop or scale any part of the mark.
5. Invert or mirror the mark.
6. Add a drop shadow, glow, outline or change the colours of the mark, or create a pattern or design element.
7. Place on any background that is too busy or distracting.
8. Modify or substitute any of the fonts. Only Arial Bold should be used.
9. Rotate the horizontal variant to vertical and vice versa.

Horizontal Variant – Cartons and Packet drinks

Correct Application of the Full Nutri-Grade mark on Cartons, Packet Drinks and Sachets

Please ensure that:

1. The horizontal variant is used as the default, where possible.
2. The $(H+W) / 7$ formula is applied to calculate the minimum size of the Nutri-Grade mark on FOP (refer to Section 4.3 for guidelines).

If HCS is applicable, refer to Section 4.4 and the Healthier Choice Symbol & Identifier Usage Guidelines.



Horizontal Variant – Cans and PET bottles



Correct Application of the Full Nutri-Grade mark on Cans and PET bottles

Please ensure that:

1. The horizontal variant is used as the default, where possible.
2. The $(H+W) / 7$ formula is applied to calculate the minimum size of the Nutri-Grade mark on FOP (refer to Section 4.3 for guidelines).

If HCS is applicable, refer to Section 4.4 and the Healthier Choice Symbol & Identifier Usage Guidelines for usage guidelines.

Length of Long Side of Horizontal Variant
 $= (H+W) / 7$
 $= (115\text{mm}+55\text{mm}) / 7$
 $= 24.3\text{mm}$

Minimum length of the horizontal variant for this packaging is 24.3mm

Length of Long Side of Horizontal Variant
 $= (H+W) / 7$
 $= (80\text{mm}+55\text{mm}) / 7$
 $= 19.3\text{mm}$
 $= 19.8\text{mm}$
 (round up to minimum size)

Minimum length of the horizontal variant for this packaging is 19.8mm

Length of Long Side of Horizontal Variant
 $= (H+W) / 7$
 $= (90\text{mm}+80\text{mm}) / 7$
 $= 24.3\text{mm}$

Minimum length of the horizontal variant for this packaging is 24.3mm

Length of Long Side of Horizontal Variant
 $= (H+W) / 7$
 $= (75\text{mm}+60\text{mm}) / 7$
 $= 19.3\text{mm}$
 $= 19.8\text{mm}$
 (round up to minimum size)

Minimum length of the horizontal variant for this packaging is 19.8mm

Vertical Variant – Cans and Bottles



Length of Long Side of Vertical Variant
 $= (H+W) / 7$
 $= (75\text{mm}+35\text{mm}) / 7$
 $= 15.7\text{mm}$
 $= 19.8\text{mm}$
 (round up to minimum size)

Minimum length of the vertical variant for this packaging is 19.8mm

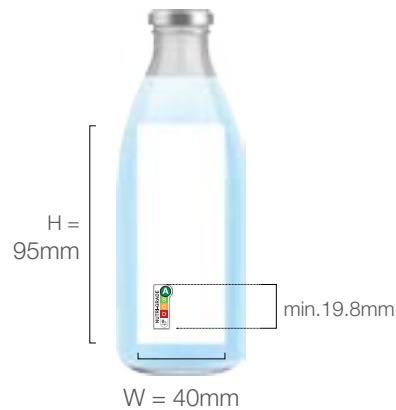

Length of Long Side of Vertical Variant
 $= (H+W) / 7$
 $= (95\text{mm}+40\text{mm}) / 7$
 $= 19.3\text{mm}$
 $= 19.8\text{mm}$
 (round up to minimum size)

Minimum length of the vertical variant for this packaging is 19.8mm



Length of Long Side of Vertical Variant
 $= (H+W) / 7$
 $= (165\text{mm}+65\text{mm}) / 7$
 $= 32.9\text{mm}$
 Minimum length of the vertical variant for this packaging is 32.9mm

Correct application of the vertical variant of the Full Nutri-Grade mark (Horizontal Variant should be used as the default, where possible).

Please ensure that:

The $(H+W) / 7$ formula is applied to calculate the minimum size of the Nutri-Grade mark on FOP (refer to Section 4.3 for guidelines).

If HCS is applicable, refer to Section 4.4 and the Healthier Choice Symbol & Identifier Usage Guidelines for usage guidelines.

Application Examples – Multipack with Identical Products within Pack



Length of Long Side
of Horizontal Variant
= $(H+W) / 7$
= $(75\text{mm}+165\text{mm}) / 7$
= 34.3mm

Minimum length of the horizontal
variant for this packaging is 34.3mm

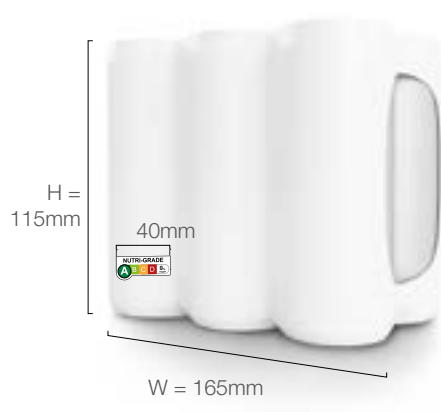

Length of Long Side
of Horizontal Variant
= $(H+W) / 7$
= $(115\text{mm}+165\text{mm}) / 7$
= 40mm

Minimum length of the horizontal
variant for this packaging is 40mm

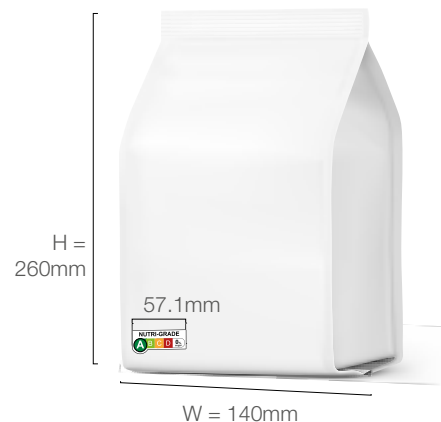

Length of Long Side
of Horizontal Variant
= $(H+W) / 7$
= $(260\text{mm}+140\text{mm}) / 7$
= 57.1mm

Minimum length of the horizontal
variant for this packaging is 57.1mm

Correct Application of the Full Nutri-Grade mark on Multipacks containing a single product type

Please ensure that:

1. The horizontal variant is used as the default, where possible.
2. The $(H+W) / 7$ formula is applied based on the height and width of the entire outer packaging (refer to Section 4.3 for guidelines).

For multipack application guidelines, please refer to Section 4.2.2. If HCS is applicable, refer to Section 4.4 and the Healthier Choice Symbol & Identifier Usage Guidelines for usage guidelines.

Application Examples – Multipack with Different Products within Pack

Fig. 1:
Product names to the left, Full Nutri-Grade marks to the right.



Fig. 2:
Product names above, Full Nutri-Grade marks below.



Fig. 3:
Simplified Nutri-Grade marks with product names on top, colour-coded scale below



Fig. 4:
Full Nutri-Grade mark on individual units in multipacks with see-through packaging



Correct Application of the Nutri-Grade mark on Multipacks containing more than one product type

Please ensure that:

1. The horizontal variant is used as the default, where possible.
2. Alternatively, you can use the Simplified Nutri-Grade mark, as shown in Fig. 3.
3. The $(H+W) / 7$ formula is applied based on the height and width of the entire outer packaging (refer to Section 4.3 for guidelines).
4. All marks on the packaging should be of the same size, regardless of grade.

For multipack application guidelines, please refer to Section 4.2.2. If HCS is applicable, refer to Section 4.4 and the Healthier Choice Symbol & Identifier Usage Guidelines for usage guidelines.

Application – Automated Beverage Dispensers

Automated Beverage Dispensers (ABDs) for non-customisable beverages means a machine that dispenses a non-pre-packaged beverage according to a pre-fixed formula, with no option for a prospective consumer of the beverage to customise the amount of any ingredient in the beverage (see example below). On the other hand, ABDs for customisable beverages allow prospective consumers to customise the ingredients of the beverage.

ABDs for customisable and non-customisable beverages are required to display the Nutri-Grade marks for beverages graded “C” or “D”

Examples of the application of the Nutri-Grade mark for ABDs for non-customisable beverages

Fig. 1a:
Fountain machine with product listing, with no customisation of sugar level

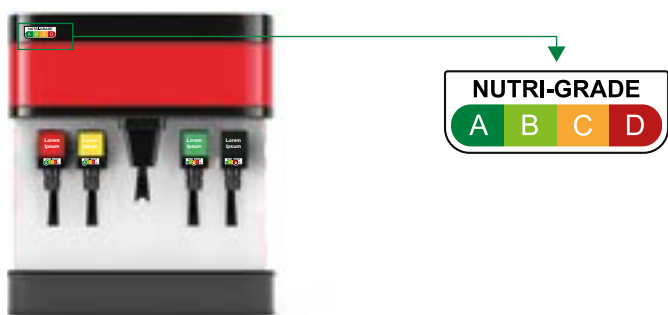

Examples of the application of the Nutri-Grade mark for ABDs for customisable beverages

Fig. 1b:
Coffee machine with text listings

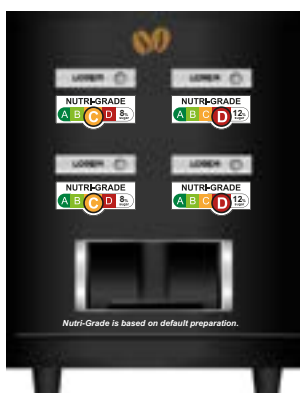

E.g. coffee machine that allows customisation of sugar level

Fig. 2a
Signage beside ABD
with Full Nutri-Grade mark

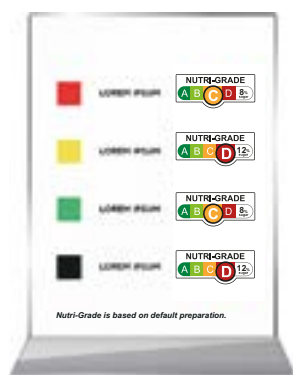
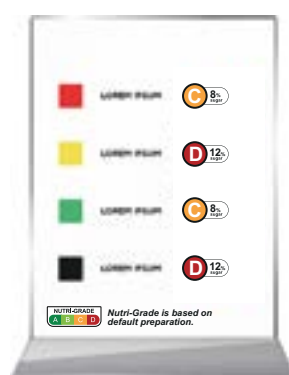

Fig. 2b
Signage beside ABD
with Simplified Nutri-Grade mark



Correct Application of the Nutri-Grade mark on consumer-facing ABDs

Where more than 1 type of beverage is dispensed, either the Full or Simplified Nutri-Grade should be used. When using the Full Nutri-Grade mark, the horizontal variant should be used.

1. The mark has to be clearly displayed on or near the ABD, with direct relation to the text/image listing of the beverage, if it is graded “C” or “D”. For ABDs for customisable beverages, the basis of the Nutri-Grade labelling should take reference from the default preparation. If there is no default preparation, it would be based on the preparation with the poorest grade.
2. Regardless of whether the Full or the Simplified Nutri-Grade mark is used, the statement stating the basis of the mark (e.g. Nutri-Grade is based on default preparation at 100% sugar (before addition of ice) has to be labelled on or near to the ABDs for customisable beverages. The statement to state the basis of grading is not applicable for ABDs for non-customisable beverages.
3. The Full or Simplified Nutri-Grade mark shall be displayed in direct relation to the image or text listing of the product, on the ABD showcasing the types of products available (refer to Fig. 1a – 1b).
4. If this is not possible (e.g. when there is no space to apply the mark without blocking the product name), the Full or Simplified Nutri-Grade mark should be displayed in an alternative form onsite, next to the ABD (e.g. signage next to the ABD) (refer to Fig. 2a and 2b).
5. For all situations, the following apply:
 - a. The position of the mark should indicate clearly to prospective consumer which product the mark applies to.
 - b. The mark can be affixed to the ABD using adhesive labels, but it should not be easily removable.
 - c. The minimum size of the Full or Simplified Nutri-Grade mark is 19.8mm long (refer to Section 4.3). When the Simplified Nutri-Grade mark is used, do ensure that the colour-coded scale is indicated on the ABD or signage, with a statement stating the basis of the mark. (only applies to customisable ABDs).
 - d. If the ABD lists the beverages available via text descriptions or if the marks are displayed on a signage next to the ABD, the height of the words “NUTRI-GRADE” in the mark should be the same as, or greater than, the height of the product name.
 - e. The size of the Simplified Nutri-Grade marks should be consistent across all beverages on the same ABD.

Note: Grade “D” beverages are not allowed to be featured on the decal wrap on vending machines and automated beverage dispensers.

Application – Vending Machines without Product Displays



Fig. 1a:
Vending machine decal wrap with individual product images labelled with the Full Nutri-Grade mark



Fig. 1b:
Vending machine decal wrap with multiple beverages listed, labelled with the Simplified Nutri-Grade mark and colour-coded scale



Correct Application of the Nutri-Grade mark on vending machines without product displays:

- If individual product images are displayed on the vending machine's decal wrap, the Full Nutri-Grade mark should be used in direct relation to each product. This can be done in 2 ways:
 - Use an image of the product with the Full Nutri-Grade mark labelled on it (refer to Fig. 1a); or
 - Display the Full Nutri-Grade mark next to the product image.
 - The minimum size of the Full or Simplified Nutri-Grade mark should be calculated based on the size of the full product image on the vending machine and not the real life product (according to guidelines listed in Section 4.3). If the image is a partial one, the size of the mark should be calculated based on the projected size of the full product image.
- If there are text listings of more than 1 product showcasing the types of products available, either the Full or Simplified Nutri-Grade mark should be displayed next to or in direct relation to the product name (refer to Fig. 1b), according to the following guidelines:
 - The height of the words "NUTRI-GRADE" on the mark should be the same as, or greater than, the height of the product name.
 - The mark should be no smaller than 19.8mm wide on the long side.
- It should be clear to prospective consumer which product the mark applies to.
- The colour-coded scale should be used if the Simplified Nutri-Grade mark is used.

Note: Grade "D" beverages are not allowed to be featured on the decal wrap on vending machines and automated beverage dispensers.

Application – E-commerce Platforms

Fig. 1a: example of digital platform with Simplified Nutri-Grade mark

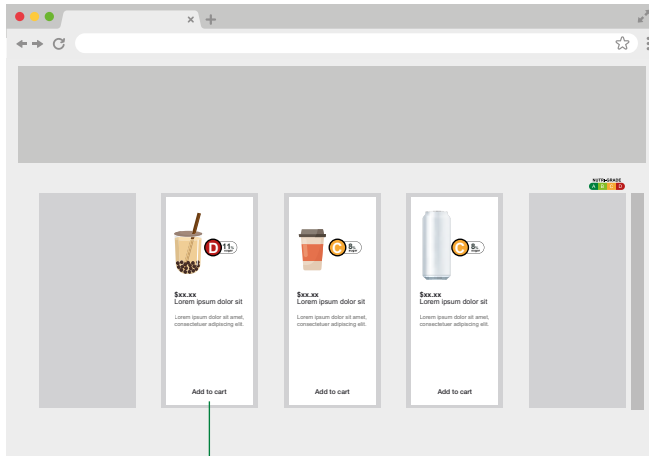
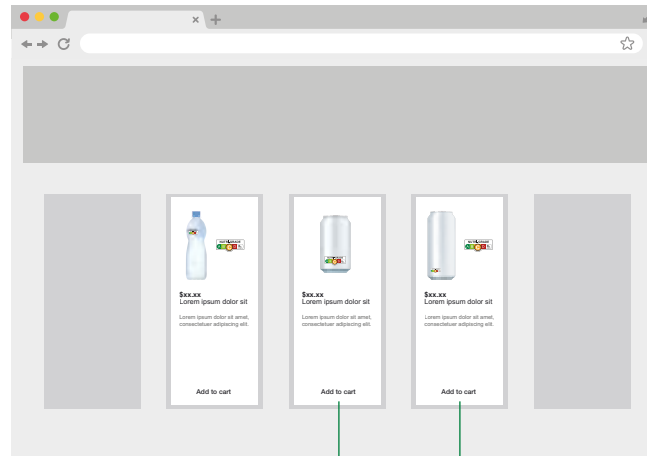

Fig. 1b: example of digital platform with Full Nutri-Grade mark



Correct Application of the Nutri-Grade mark on beverages sold on e-commerce platforms:

This applies to all digital platforms that facilitate the online sale of Nutri-Grade beverages (e.g. online variety shops, F&B digital ordering or delivery platforms).

1. Where more than 1 type of beverage is listed in the main sales page, either the Full or Simplified Nutri-Grade should be used (refer to Fig 1a and 1b). When using the Full Nutri-Grade mark, the horizontal variant should be used.

2. For individual thumbnails or pictorial listings on the main sales page, If there is an image of the product on sale, the Full or Simplified Nutri-Grade mark should be incorporated within. This can be done in 3 ways:

- a. Use an image of the labelled product with Full Nutri-Grade mark and ensure that it is clearly displayed (refer to Fig. 2a); or
- b. Display the Full Nutri-Grade mark next to the product image (refer to Fig. 2b). The (H+W) / 7 formula should be applied based on the size of the product image to calculate the size of the Full Nutri-Grade mark (refer to Section 4.3). If the image is a partial one, the size of the mark should be calculated based on the projected size of the full product image; or
- c. Display the Simplified Nutri-Grade mark next to the product image in the thumbnail on the main sales page. The colour-coded scale must be visible on the same display (refer to Fig 1a) as the listed beverage and the Simplified Nutri-Grade mark, without requiring a person to scroll up or down or click any links.

Fig. 2c – Thumbnail featuring Simplified Nutri-Grade mark, with colour-coded scale indicated outside the thumbnail, and within the same screen

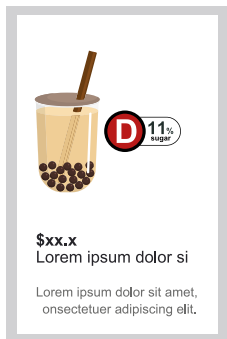

Fig. 2a – Thumbnail featuring product with Full Nutri-Grade mark on its FOP



Fig. 2b – Thumbnail featuring Full Nutri-Grade mark beside the product



Application – E-commerce Platforms

Fig. 3a – Individual product sales page with Full Nutri-Grade mark

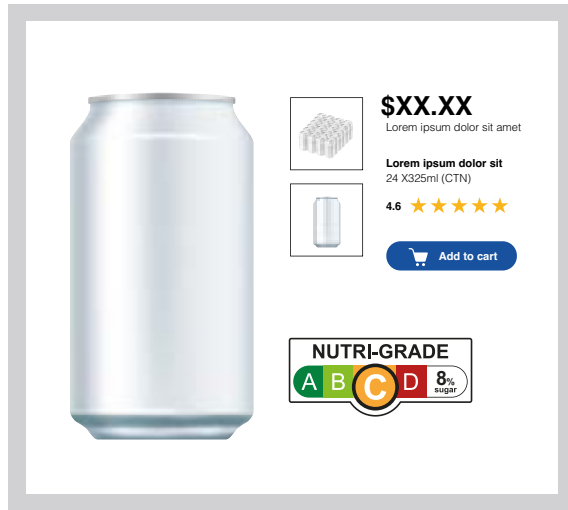

Fig. 4a – Text-listing of the product on sale, with the Full Nutri-Grade mark

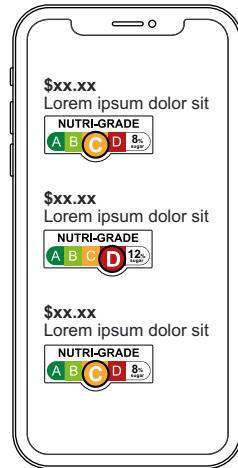
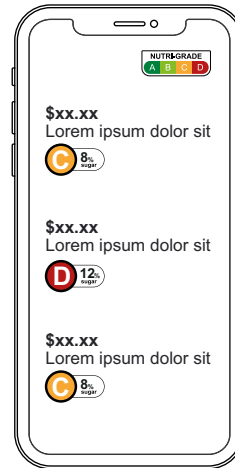

Fig. 4b – Text-listing of the product on sale, with the Simplified Nutri-Grade mark



Correct Application of the Nutri-Grade mark on beverages sold on e-commerce platforms:

3. For individual product sales page, unless the product is a multipack of more than 1 type of beverage, only the Full Nutri-Grade mark in its horizontal variant is allowed (refer to Fig. 3a).
4. If there is only a text listing of the product on sale, the Full or Simplified Nutri-Grade mark should be displayed next to or in direct relation to the product name.
 - a. If the Full Nutri-Grade mark is used, the height of the words “NUTRI-GRADE” in the mark should be the same as, or greater than, the height of the product name (refer to Fig. 4a).
 - b. If the Simplified Nutri-Grade mark is used, the colour-coded scale must also be visible on the same page without requiring a person to scroll up or down or click any links (refer to Fig. 4b).

Correct Application of the Sugar Declaration of Toppings marks for beverages sold on e-commerce platforms:

A Sugar Declaration for Toppings mark should be displayed next to or in direction relation to the product name or image (refer to Fig 5a).

Alternative Plain Text Display of the Sugar Declaration for Toppings mark is allowed when the display of Sugar Declaration for Topping mark is not possible, such as when there are limitations on digital and app platforms which only allows for the display of text and not images (refer to Fig 5b).

The key components of the Sugar Declaration for Toppings mark must be reflected (i.e. the incremental amount of sugar from the toppings, reflected in terms of % per 100g of toppings).

Fig. 5a – Individual product sales page with Simplified Nutri-Grade mark and Sugar Declaration for Toppings mark

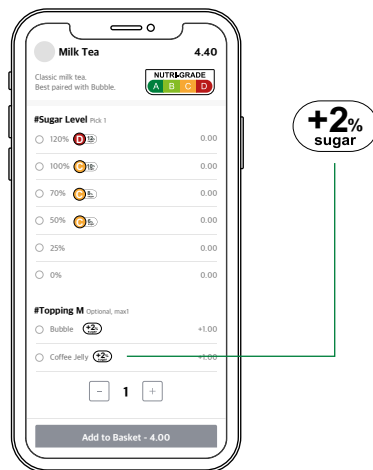
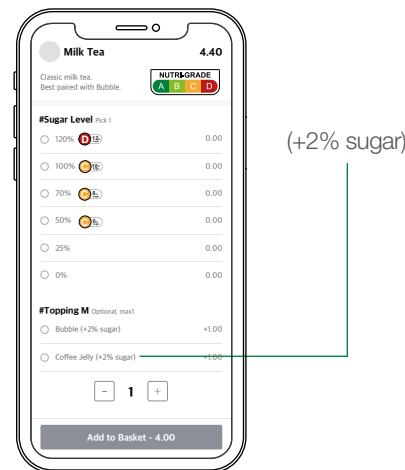

Fig. 5b – Alternative plain text display etc



Application – Digital Advertisements

Correct Application of the Nutri-Grade mark for digital advertisements:

In all situations, the horizontal variant of the Nutri-Grade mark should be used as the default, where possible except at Point-of-Sale platforms within variety shops and online variety shops.

Please note that advertisements, except at Point-of-Sale platforms for pre-packaged beverages within variety shops and online variety shops, are prohibited from featuring beverages graded D. It is optional for advertisements featuring beverages graded “A”, “B”, or “C” to display the Nutri-Grade mark. Advertisements featuring pre-packaged beverages graded “D” in variety shops and online variety shops are required to be labelled with the Nutri-Grade mark.

A variety shop includes a convenience store, grocery shop, supermarket or other establishment however named that sells mainly a variety of food, small household items, toiletries and other small consumer goods.

Fig. 1:
Web Banners

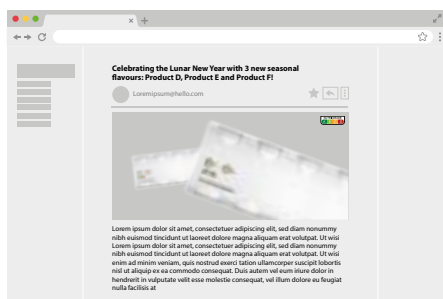

Fig. 2:
Video Ads

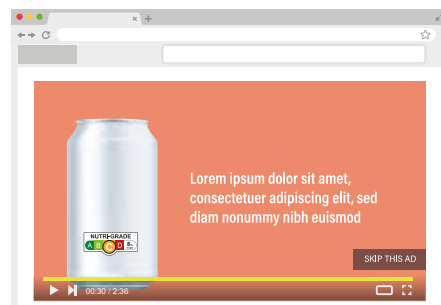

Fig. 3:
Promotional Emails

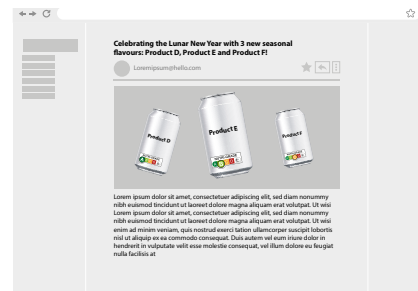
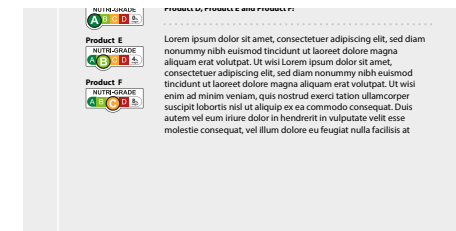

Fig. 4:
Text-only Advertisements



1. If there is an image of the product being advertised, the Nutri-Grade mark should be applied to the image. This can be done in 2 ways:

- Use an image of the labelled product; or
- Display the Nutri-Grade mark next to the product image. The $(H+W)/7$ formula should be applied based on the size of the product image to calculate the size^{*} of the Nutri-Grade mark (refer to Section 4.3). If the image is a partial one, the size^{*} of the mark should be calculated based on the projected size of the full product image.

2. If there is only a text listing of the product being advertised, the Nutri-Grade mark should be displayed next to or in direct relation to the product name.

The height[^] of the words “NUTRI-GRADE” in the mark should be the same as, or greater than, the height of the product name (refer to Fig. 4).

3. The Nutri-Grade mark must appear in direct relation to the product of concern, by locating it on/next to the product (refer to Fig. 1 - 3). If this is not possible and the Nutri-Grade mark is located away from the product, the mark should be labelled with the product name (refer to Fig. 4).

4. If there are multiple features (image/text) of the same product on the advertisement, only one mark is required. For situations described in Scenarios 1b and 2, the size^{*} of the Nutri-Grade mark is calculated based on the largest feature of the product.

If the Nutri-Grade mark within the product image (Scenario 1a) is not clearly legible across online platforms (e.g. desktop or mobile), Scenario 1b should be used to display the mark at a larger and more legible size.

* The size of the Nutri-Grade marks should be roughly consistent across all beverages of similar sizes on the same advertisement.
^ The height of the words “NUTRI-GRADE” should be roughly consistent across all beverages of similar sizes on the same advertisement.

Application – Materials that inform sale of Nutri-Grade beverage¹

Beverages graded “C” or “D” listed on the following materials, are required to be labelled with a Full or Simplified Nutri-Grade mark. Toppings listed on the following materials, are required to be labelled with the Sugar Declaration for Toppings mark.

Examples of materials required to be labelled



Materials that contain the name and/or image of beverages, found within the rental/leased/ purchased space of physical F&B establishments, and that can be seen by a prospective consumer. These include:

- Paper menus, laminated menus on counter, inserts or separate menu for new/ seasonal items;
- Table standees, tray liners, menu boards, pull up banners; and
- Onsite signages that are on, or near to, containers of beverages that are on display for self service



Materials that contain the name and/or image of beverages, found within the online locations of sale. These include:

- Menus at self order kiosk;
- Images of beverages within the F&B store on a consolidated food delivery app; and
- Entire food delivery apps from specific F&B establishments.



Materials that contain the name and/or image of beverages and used to present offerings from catering or non-F&B establishments.

Catering menus sent to the host/organizer of the event to make order selection as well as signages/ materials at the premise of the catered events to label the type of beverage offered

- Preschool menus sent to parents, or put up at the preschool premise
- Menus given to hospital patients
- Menus given to inmates of a correctional facility
- Menus given to passengers of a transportable vehicle

¹ Examples include menus, posters, signs, etc that list or inform the sale of a Nutri-Grade beverage within online and physical stores

Application – Materials that inform sale of Nutri-Grade beverage¹

For a freshly prepared beverage which ingredient(s) may be customised by a prospective consumer (including those dispensed from a consumer-facing customisable automated beverage dispenser), a statement regarding the basis of the grading has to be included at least once on every menu, poster, sign or other material that inform its sale.

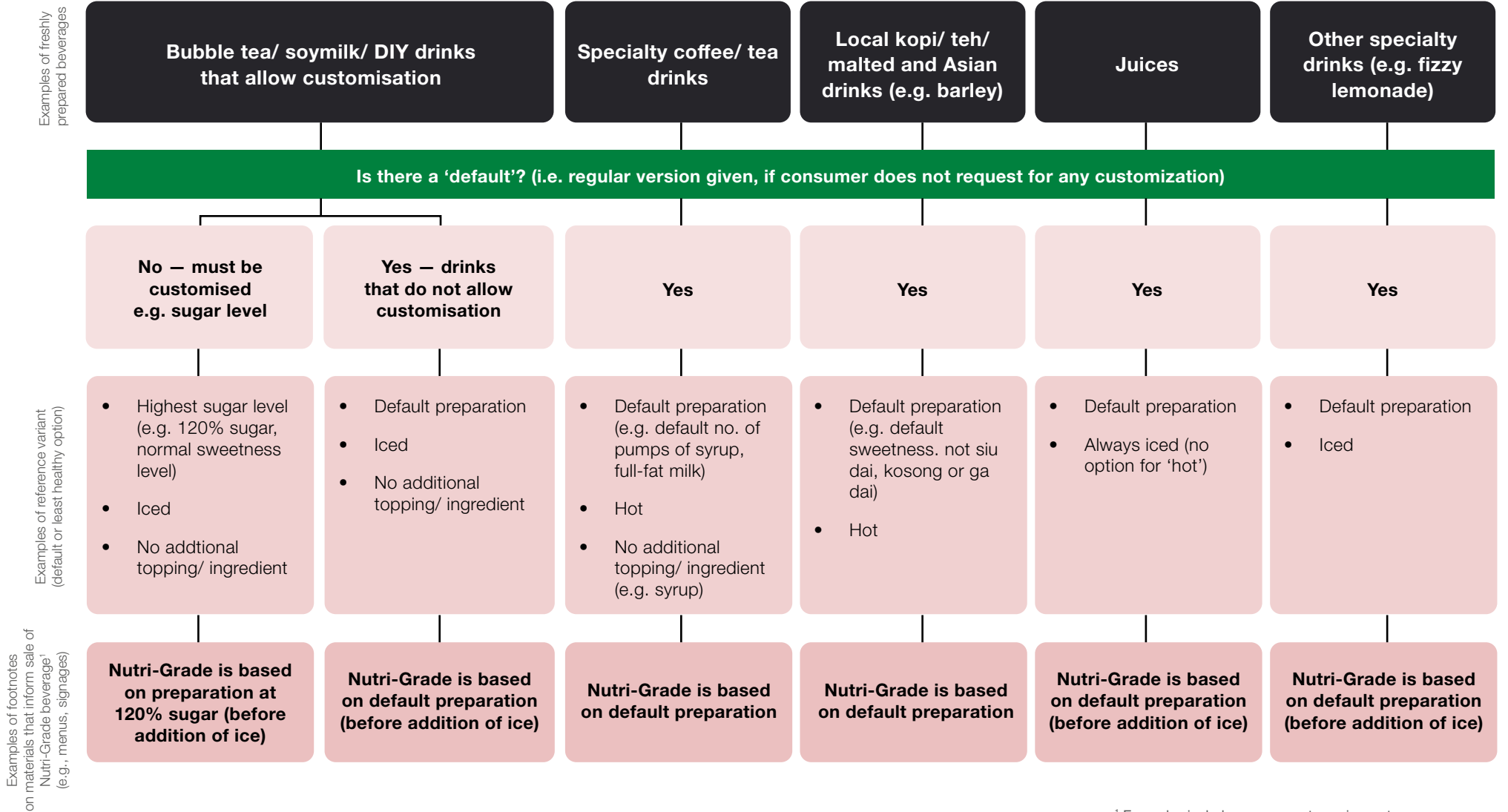

¹ Examples include menus, posters, signs, etc.

Application – Materials that inform sale of Nutri-Grade beverage¹

General placement requirements for physical and digital menus

- The Simplified Nutri-Grade mark should be adjacent to the name or price of the beverage item.
- The Sugar Declaration for Toppings mark should be adjacent to the toppings.

Physical menu

Milk Tea

Earl Grey Milk Tea		\$2.80
Pearl Milk Tea		\$2.80
Milk Tea with Herbal Jelly		\$3.20
Brown Sugar Milk Tea		\$3.80
Taro Drink		\$4.00

Creative Mix

Passion Fruit Green Tea		\$2.80
Lemon Juice with White Pearl & Aiyu		\$2.80
Mango Green Tea		\$3.20
Lemon with Aloe Vera		\$3.80

Hot Tea

Lemon Lime Green Tea		\$2.80
Yuzu Oolong Tea		\$2.80

Choose Your Sugar Level

Sugar level

- Full Sugar (100%)
- Less Sugar (70%)
- Half Sugar (50%)
- Quarter Sugar (30%)
- No Sugar (0%)

Choose Your Toppings

- Topping A (+2% sugar)
- Topping B (+2% sugar)
- Topping C (+3% sugar)
- Topping D (+3% sugar)
- Topping E (+4% sugar)
- Topping F (+4% sugar)

Fig 1a

Digital menu

Milk Tea

Earl Grey Milk Tea		\$2.80
Pearl Milk Tea		\$2.80

Choose Your Toppings

#Topping M Optional, max1

- Bubble **+2% sugar** +1.00
- Coffee Jelly **+2% sugar** +1.00

Choose Your Toppings

- Topping A (+2% sugar) +1.00
- Topping B (+2% sugar) +1.00
- Topping C (+3% sugar) +1.00
- Topping D (+3% sugar) +1.00
- Topping E (+4% sugar) +1.00
- Topping F (+4% sugar) +1.00

Fig 1b

Fig 1c

Fig 1d

Placement requirements for colour-coded scale

Physical menu

- The colour-coded scale and statement stating the basis of the Nutri-Grade mark for freshly prepared beverages must be visible on the menu (Refer to Fig 1a.)

Electronic menus and e-commerce platforms











- The colour-coded scale and statement stating the basis of the Nutri-Grade mark for freshly prepared beverages must be visible on the same display as the listed beverage and the Simplified Nutri-Grade mark, without requiring a person to scroll up or down or click any links. (Refer to Fig 1b.)
- Text Variant for sugar declaration of toppings (Fig 1d) is only allowed when the display of Sugar Declaration for Toppings mark (Fig 1c) is not possible, such as when there are limitations on digital and app platforms which only allow for the display of text and not images. The key components of the Sugar Declaration for Toppings mark must be reflected (i.e., the incremental amount of sugar from the toppings, reflected in terms of % per 100g of toppings).

¹ Examples include menus, posters, signs, etc.

Application – Materials that inform sale of Nutri-Grade beverage¹

General placement requirements for menus in non-F&B settings (e.g., preschool menus)

- The Simplified Nutri-Grade mark should be adjacent to the name or price of the beverage item.
- The colour-coded scale and statement stating the basis of the Nutri-Grade mark for freshly prepared beverages must be visible on the menu.

Week 1	Morning Snack	Lunch	Afternoon Snack
Monday	Brown Rice Ring Cereal + Milk 	Gluten-free Pesto Pasta, Assorted Vegetable Salad, Fresh Fruits <small>(with spinach, pesto sauce, cherry tomatoes)</small>	Hokkaido Milk Toast + Milk 
Tuesday	Wholemeal Bread with Light Cream Cheese + Milk 	Sauté Cauliflower, Mixed Brown Rice, Assorted Vegetable Salad, Fresh Fruits <small>(with broccoli, carrot & capsicum)</small>	ABC Biscuit + Milk 
Wednesday	California Raisin Bread + Milk 	Saute Celery, Carrot & Corn, Mixed Brown Rice, Assorted Vegetable Salad, Fresh Fruits	Oatmeal Cookies + Milk 
Thursday	Brown Rice Ring Cereal + Milk 	Fried Brown Rice, Assorted Vegetable Salad, Fresh Fruits <small>(with carrot, corn, broccoli)</small>	Pandan Bread + Milk 
Friday	Brown Rice Ring Cereal + Milk 	Sauté Cauliflower, Mixed Brown Rice, Assorted Vegetable Salad, Fresh Fruits <small>(with capsicum, carrot & black fungus)</small>	Mantou + Milk 



¹ Examples include menus, posters, signs, etc.